

# YAMAHA

# RX-V692RDS

# RX-V592RDS

*Natural Sound AV Receiver*

*Récepteur audiovisuel "Son Naturel"*

*Natural Sound AV-Receiver*

*Natural Sound AV-receiver*

*Sintonizzatore AV a suono naturale*

*Receptor AV de Sonido Natural*

*Natural Sound AV Ontvanger*

**OWNER'S MANUAL  
MODE D'EMPLOI  
BEDIENUNGSANLEITUNG  
BRUKSANVISNING  
MANUALE DI ISTRUZIONI  
MANUAL DE INSTRUCCIONES  
GEBRUIKSAANWIJZING**

**SUPPLIED ACCESSORIES**  
**ACCESSOIRES FOURNIS**  
**MITGELIEFERTE ZUBEHÖRTEILE**  
**MEDFÖLJANDE TILLBEHÖR**  
**ACCESSORI IN DOTAZIONE**  
**ACCESORIOS INCLUIDOS**  
**BIJGELEVERDE ACCESSOIRES**

- After unpacking, check that the following parts are included.
- Après le déballage, vérifier que les pièces suivantes sont incluses.
- Nach dem Auspacken überprüfen, ob die folgenden Teile vorhanden sind.
- Kontrollera efter det apparaten packats upp att följande delar finns med.
- Verificare che tutte le parti seguenti siano contenute nell'imballaggio dell'apparecchio.
- Desembalar el aparato y verificar que los siguientes accesorios están en la caja.
- Controleer na het uitpakken of de volgende onderdelen voorhanden zijn.

- Indoor FM Antenna
- Antenne FM intérieure
- UKW-Innenantenne
- FM inomhusantenn
- Antenna FM interna
- Antena FM interior
- FM Binnenantenne

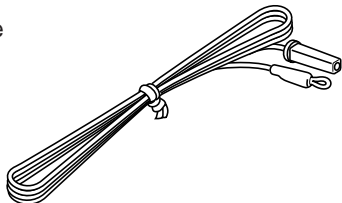

- Remote Control Transmitter
- Emetteur de télécommande
- Fernbedienung
- Fjärrkontroll
- Telecomando
- Transmisor del control remoto
- Afstandbediening

**RX-V692RDS**

**RX-V592RDS**

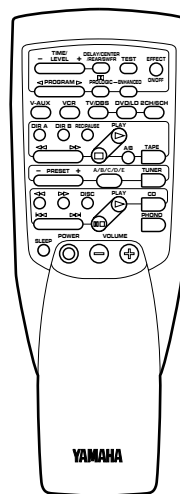
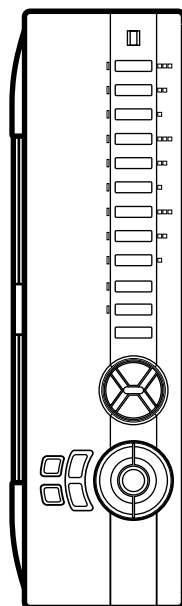

- AM Loop Antenna
- Cadre-antenna AM
- MW-Rahmenantenne
- AM ramantenn
- Antenna AM ad anello
- Antena de cuadro de AM
- AM Lusantenne

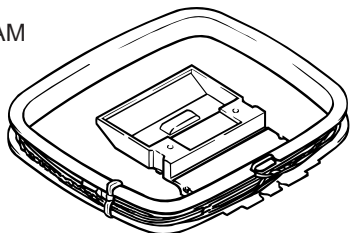

- 75-ohm/300-ohm antenna adapter (U.K. model only)
- Adaptateur d'antenne 75 ohms/300 ohms (Modèle pour le Royaume-Uni seulement)
- 75 Ohm/300 Ohm Antennenstecker (nur Großbritannien-Modell)
- 75 ohm/300 ohm antennadapter (Endast modell för Storbritannien)
- Adattatore per antenna da 75 e 300 ohm (Solo modello per la Gran Bretagna)
- Adaptador de antena de 75 ohmios/300 ohmios (Modelo para Reino Unido sólo)
- 75 ohm/300 ohm antenne-adapter (Alleen modellen voor Groot-Brittannië)

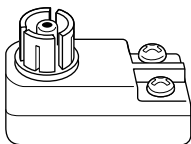

- User function stickers **RX-V692RDS only**
- Etiquettes de fonctions d'utilisateur **RX-V692RDS seulement**
- Etiketten für Anwenderfunktionen **nur RX-V692RDS**
- Etiketter för din egen användning **Endast RX-V692RDS**
- Etichette ad uso dell'utente **Solo per l'RX-V692RDS**
- Etiqueta de funciones del usuario **Sólo RX-V692RDS**
- Gebruikersfunctie-stickers **Alleen RX-V692RDS**

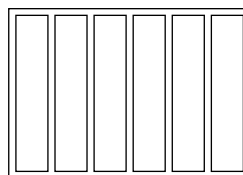

- Batteries (size AA, R6, UM-3)
- Piles (taille AA, R6, UM-3)
- Batterien (Größe AA, R6, UM-3)
- Batterier (storlek AA, R6, UM-3)
- Batterie (dimensioni AA, R6, UM-3)
- Pilas (tamaño AA, R6, UM-3)
- Batterijen (maat AA, R6, UM-3)

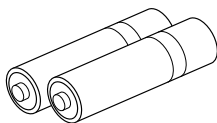

## FEATURES

### ● 5 Speaker Configuration

#### **RX-V692RDS**

**Main:** 75W + 75W (8Ω) RMS Output Power, 0.04% THD, 20–20,000 Hz

**Center:** 75W (8Ω) RMS Output Power, 0.07% THD, 20–20,000 Hz

**Rear:** 40W + 40W (8Ω) RMS Output Power, 0.3% THD, 1 kHz

#### **RX-V592RDS**

**Main:** 70W + 70W (8Ω) RMS Output Power, 0.04% THD, 20–20,000 Hz

**Center:** 70W (8Ω) RMS Output Power, 0.07% THD, 20–20,000 Hz

**Rear:** 35W + 35W (8Ω) RMS Output Power, 0.3% THD, 1 kHz

- Digital Sound Field Processor
- Dolby Pro Logic Surround Decoder
- Theater-like Sound Experience by the Combination of Dolby Pro Logic and YAMAHA DSP Technology (CINEMA DSP)
- Automatic Input Balance Control for Dolby Pro Logic Surround
- Test Tone Generator for Easier Speaker Balance Adjustment

### ● 3 Center Channel Modes (NORMAL/WIDE/PHANTOM)

- BASS EXTENSION Switch for Reinforcing Bass Response
- Multi-Functions for RDS Broadcast Reception
- 40-Station Random Access Preset Tuning
- Automatic Preset Tuning
- Preset Station Shifting Capability (Preset Editing)
- IF Count Direct PLL Synthesizer Tuning System
- Video Signal Input/Output Capability
- 6-Channel Discrete Input Terminals for Connecting with a Dolby Digital (AC-3) Decoder
- SLEEP Timer
- Remote Control Capability

#### **RX-V692RDS only**

- “Learning” Remote Control Transmitter

## CONTENTS

Supplied Accessories .....	2	Tuning Operations .....	28
Caution .....	4	Preset Tuning .....	29
Notes about the Remote Control Transmitter .....	5	Receiving RDS Stations .....	32
Profile of This Unit .....	6	Using Digital Sound Field Processor (DSP) .....	37
Speaker Setup .....	7	Setting the SLEEP Timer .....	42
Connections .....	8	Remote Control Transmitter .....	
Controls and Their Functions .....	16	<b>RX-V692RDS only</b> .....	43
Speaker Balance Adjustment .....	22	Troubleshooting .....	53
Basic Operations .....	25	Specifications .....	54

# CAUTION : READ THIS BEFORE OPERATING YOUR UNIT.

1. To assure the finest performance, please read this manual carefully. Keep it in a safe place for future reference.
2. Install this unit in a cool, dry, clean place – away from windows, heat sources, sources of excessive vibration, dust, moisture and cold. Avoid sources of humming (transformers, motors). To prevent fire or electrical shock, do not expose the unit to rain or water.
3. Never open the cabinet. If something drops into the set, contact your dealer.
4. Do not use force on switches, controls or connection wires. When moving the unit, first disconnect the power plug and the wires connected to other equipment. Never pull the wires themselves.
5. The openings on the cabinet assure proper ventilation of the unit. If these openings are obstructed, the temperature inside the cabinet will rise rapidly. Therefore, avoid placing objects against these openings, and install the unit in well-ventilated condition. Make sure to allow a space of at least 20 cm behind, 20 cm on the both sides and 30 cm above the top panel of the unit. Otherwise it may not only damage the unit, but also cause fire.
6. Always set the VOLUME control to “- ∞” before starting the audio source play. Increase the volume gradually to an appropriate level after playback has been started.
7. Do not attempt to clean the unit with chemical solvents; this might damage the finish. Use a clean, dry cloth.
8. Be sure to read the “TROUBLESHOOTING” section regarding common operating errors before concluding that the unit is faulty.
9. When not planning to use this unit for long periods of time (ie., vacation, etc.), disconnect the AC power plug from the wall outlet.
10. To prevent lightning damage, disconnect the AC power plug and disconnect the antenna cable when there is an electrical storm.
11. Grounding or polarization – Precautions should be taken so that the grounding or polarization of an appliance is not defeated.
12. AC outlet  
Do not connect audio equipment to the AC outlet on the rear panel if that equipment requires more power than the outlet is rated to provide.

## IMPORTANT

Please record the serial number of this unit in the space below.

Serial No.:

The serial number is located on the rear of the unit. Retain this Owner's Manual in a safe place for future reference.

## WARNING

TO REDUCE THE RISK OF FIRE OR ELECTRIC SHOCK, DO NOT EXPOSE THIS UNIT TO RAIN OR MOISTURE.

## For U.K. customers

If the socket outlets in the home are not suitable for the plug supplied with this appliance, it should be cut off and an appropriate 3 pin plug fitted. For details, refer to the instructions described below.

**Note:** The plug severed from the mains lead must be destroyed, as a plug with bared flexible cord is hazardous if engaged in a live socket outlet.

## Special Instructions for U.K. Model

### IMPORTANT

THE WIRES IN THE MAINS LEAD ARE COLOURED IN ACCORDANCE WITH THE FOLLOWING CODE:

Blue: NEUTRAL

Brown: LIVE

As the colours of the wires in the main lead of this apparatus may not correspond with the coloured markings identifying the terminals in your plug, proceed as follows:

The wire which is coloured BLUE must be connected to the terminal which is marked with the letter N or coloured BLACK. The wire which is coloured BROWN must be connected to the terminal which is marked with the letter L or coloured RED. Make sure that neither core is connected to the earth terminal of the three pin plug.

The apparatus is not disconnected from the AC power source as long as it is connected to the wall outlet, even if the apparatus itself is turned off.

## WARNING

Do not change the IMPEDANCE SELECTOR switch setting while the power to this unit is on, otherwise this unit may be damaged.

### IMPEDANCE SELECTOR

(Europe model)

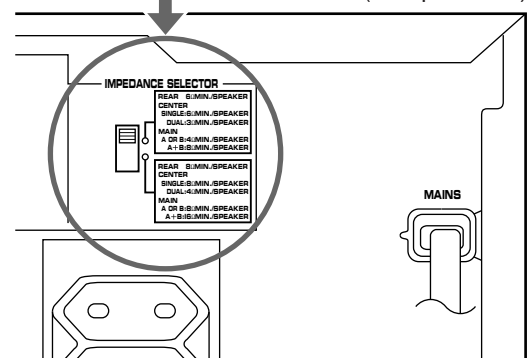

# NOTES ABOUT THE REMOTE CONTROL TRANSMITTER

## Battery installation

## Remote control transmitter operation range

### RX-V692RDS

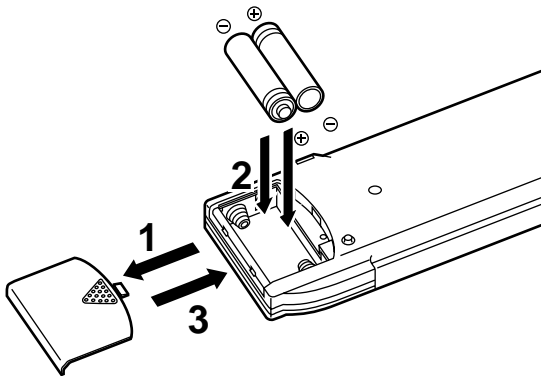

### RX-V592RDS

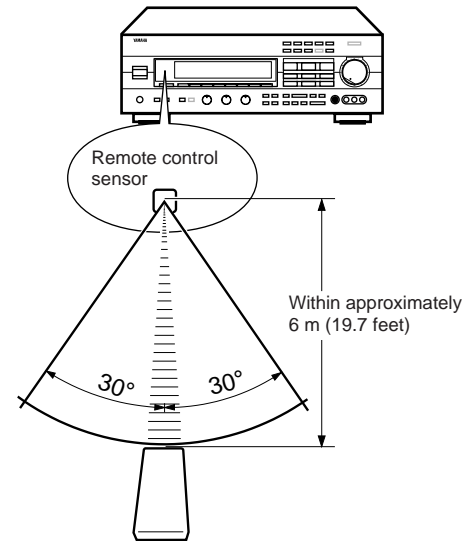
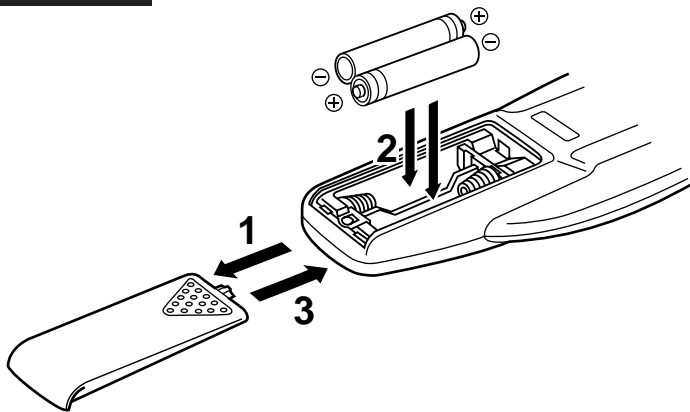

### Notes

- There should be no large obstacles between the remote control transmitter and the main unit.
- If the remote control sensor is directly illuminated by strong lighting (especially an inverter type of fluorescent lamp etc.), it might cause the remote control transmitter not to work correctly. In this case, reposition the main unit to avoid direct lighting.

## Battery replacement

If you find that the remote control transmitter must be used closer to the main unit, the batteries are weak. Replace both batteries with new ones.

### Notes

- Use only AA, R6, UM-3 batteries for replacement.
- Be sure the polarities are correct. (See the illustration inside the battery compartment.)
- Remove the batteries if the remote control transmitter will not be used for an extended period of time.
- If batteries leak, dispose of them immediately. Avoid touching the leaked material or letting it come in contact with clothing, etc. Clean the battery compartment thoroughly before installing new batteries.
- **RX-V692RDS only**  
After you change batteries, make sure to press the **RESET** button inside the battery compartment.

# PROFILE OF THIS UNIT

You are the proud owner of a Yamaha stereo receiver –an extremely sophisticated audio component. The Digital Sound Field Processor (DSP) built into this unit takes advantage of Yamaha's undisputed leadership in the field of digital audio processing to bring you a whole new world of listening experiences. Follow the instructions in this manual carefully when setting up your system, and this unit will sonically transform your room into a wide range of listening environments –movie theater, concert hall, and so on. In addition, you get incredible realism from sources encoded with Dolby Surround using the built-in Dolby Pro Logic Surround Decoder.

Please read this operation manual carefully and store it in a safe place for later reference.

## Digital Sound Field Processing

---

What is it that makes live music so good? Today's advanced sound reproduction technology lets you get extremely close to the sound of a live performance, but chances are you'll still notice something missing: the acoustic environment of the live concert hall. Extensive research into the exact nature of the sonic reflections that create the ambience of a large hall has made it possible for Yamaha engineers to bring you this same sound in your own listening room, so you'll feel all the sound of a live concert.

Furthermore, our technicians, armed with sophisticated measuring equipment, have even made it possible to capture the acoustics of a variety of venues such as an actual concert hall, theater, etc. to allow you to accurately recreate one of several actual live performance environments, all in your own home.

## Dolby Pro Logic Surround

---

This unit employs a Dolby Pro Logic Surround decoder similar to professional Dolby Stereo decoders used in many movie theaters. By using the Dolby Pro Logic Surround decoder, you can experience the dramatic realism and impact of Dolby Surround movie theater sound in your own home. Dolby Pro Logic employs a four channel five speaker system. The Pro Logic Surround system divides the input signal into four levels: the left and right main channels, the center channel (used for dialog), and the rear surround sound channels (used for sound effects, background noise, and other ambient noises). The center channel allows listeners seated in even less-than-ideal positions to hear the dialog originating from the action on the screen while experiencing good stereo imaging. Dolby Surround is encoded on the sound track of pre-recorded video tapes, laser discs, and some TV/cable broadcasts. When you play a source encoded with Dolby Surround on this unit, the Dolby Pro Logic Surround decoder decodes the signal and distributes the surround-sound effects.

This Dolby Pro Logic Surround Decoder employs a digital signal processing system. This system improves the stability of sound at each channel and minimizes crosstalk between channels, so that positioning of sounds around the room is more accurate compared with conventional analog signal processing systems. In addition, this unit features a built-in automatic input balance control. This always assures you the best performance without manual adjustment.

Manufactured under license from Dolby Laboratories Licensing Corporation. "Dolby", "AC-3", "Pro Logic", and the double-D symbol are trademarks of Dolby Laboratories Licensing Corporation.

## Dolby Pro Logic Surround + DSP

---

Dolby Surround sound system shows its full ability in a large movie theater, because movie sounds are originally designed to be reproduced in a large movie theater using many speakers. It is difficult to create a sound environment similar to that of a movie theater in your listening room, because the room size, materials of inside walls, the number of speakers, etc. of your listening room is much different from those of a movie theater.

Yamaha DSP technology made it possible to present you with nearly the same sound experience as that of a large movie theater in your listening room by compensating for lack of presence and dynamics in your listening room with its original digital sound fields combined with Dolby Surround sound field.

The combination of Dolby Pro Logic Surround and DSP is used on the sound field program "  PRO LOGIC ENHANCED".

### **RX-V692RDS only**

This combination is used on sound field programs "  PRO LOGIC ENHANCED", "70 mm MOVIE THEATER" and "TV SPORTS".

### **CINEMA DSP**

The YAMAHA "CINEMA DSP" logo indicates these programs are created by the combination of Dolby Pro Logic and YAMAHA DSP technology.

# SPEAKER SETUP

## SPEAKERS TO BE USED

This unit is designed to provide the best sound-field quality with a 5 speaker configuration. The most effective speakers to use with this unit are main speakers, rear speakers and a center speaker. You may omit the center speaker. (Refer to the “**4-Speaker Configuration**” shown below.)

The main speakers are used for the main source sound plus the effect sounds. They will probably be the speakers from your present stereo system. The rear speakers are used for the effect and surround sounds, and the center speaker is for the center sounds (dialog etc.) within programs encoded with Dolby Surround. The center speaker needs to be equal in power to the main speakers, although the rear speakers should not be equal. However, all the speakers should have high enough power handling to accept the maximum output of this unit.

## SPEAKER CONFIGURATION

### 5-Speaker Configuration

This configuration is the most effective and recommended one. In this configuration, the center speaker is necessary as well as the rear speakers. If one of the programs shown below is selected, conversations will be output from the center speaker and the ambience will be excellent.

- PRO LOGIC
- PRO LOGIC ENHANCED
- 70 mm MOVIE THEATER **RX-V692RDS only**
- TV SPORTS **RX-V692RDS only**

**Note:** Set the center channel mode to the “NORMAL” or “WIDE” position. (For details, refer to page 23.)

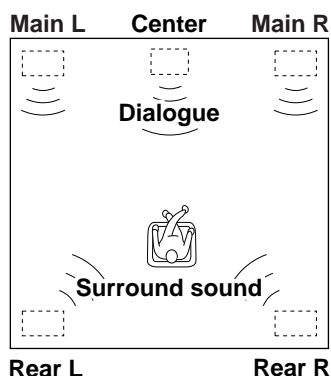

### 4-Speaker Configuration

The center speaker is not used in this configuration. If one of the programs shown below is selected, the center sound is output from the left and the right main speakers. However, the sound effect of other programs can be the same as that of the 5-speaker configuration.

- PRO LOGIC
- PRO LOGIC ENHANCED
- 70 mm MOVIE THEATER **RX-V692RDS only**
- TV SPORTS **RX-V692RDS only**

**Note:** Be sure to set the center channel mode to the “PHANTOM” position. (For details, refer to page 23.)

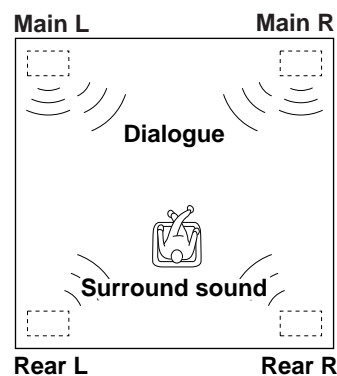

## SPEAKER PLACEMENT

The recommended speaker configuration, the 5-speaker configuration, will require two speaker pairs: **main speakers** (your normal stereo speakers), and **rear speakers**, plus a **center speaker**. When you place these speakers, refer to the following.

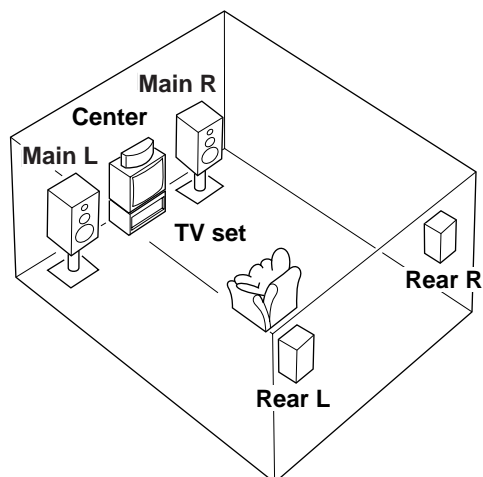

- Main:** In normal position. (The position of your present stereo speaker system.)
- Rear:** Behind your listening position, facing slightly inward. Nearly six feet (approx. 1.8 m) up from the floor.
- Center:** Precisely between the main speakers. (To avoid interference with TV sets, use a magnetically shielded speaker.)

# CONNECTIONS

Never plug in this unit and other components until all connections are completed.

## CONNECTIONS WITH OTHER COMPONENTS

When making connections between this unit and other components, be sure all connections are made correctly, that is to say L (left) to L, R (right) to R, “+” to “+” and “-” to “-”. Also, refer to the owner’s manual for each component to be connected to this unit.

\* If you have YAMAHA components numbered as 1, 2, 3, etc. on the rear panel, connections can be made easily by making sure to connect the output (or input) terminals of each component to the same-numbered terminals of this unit.

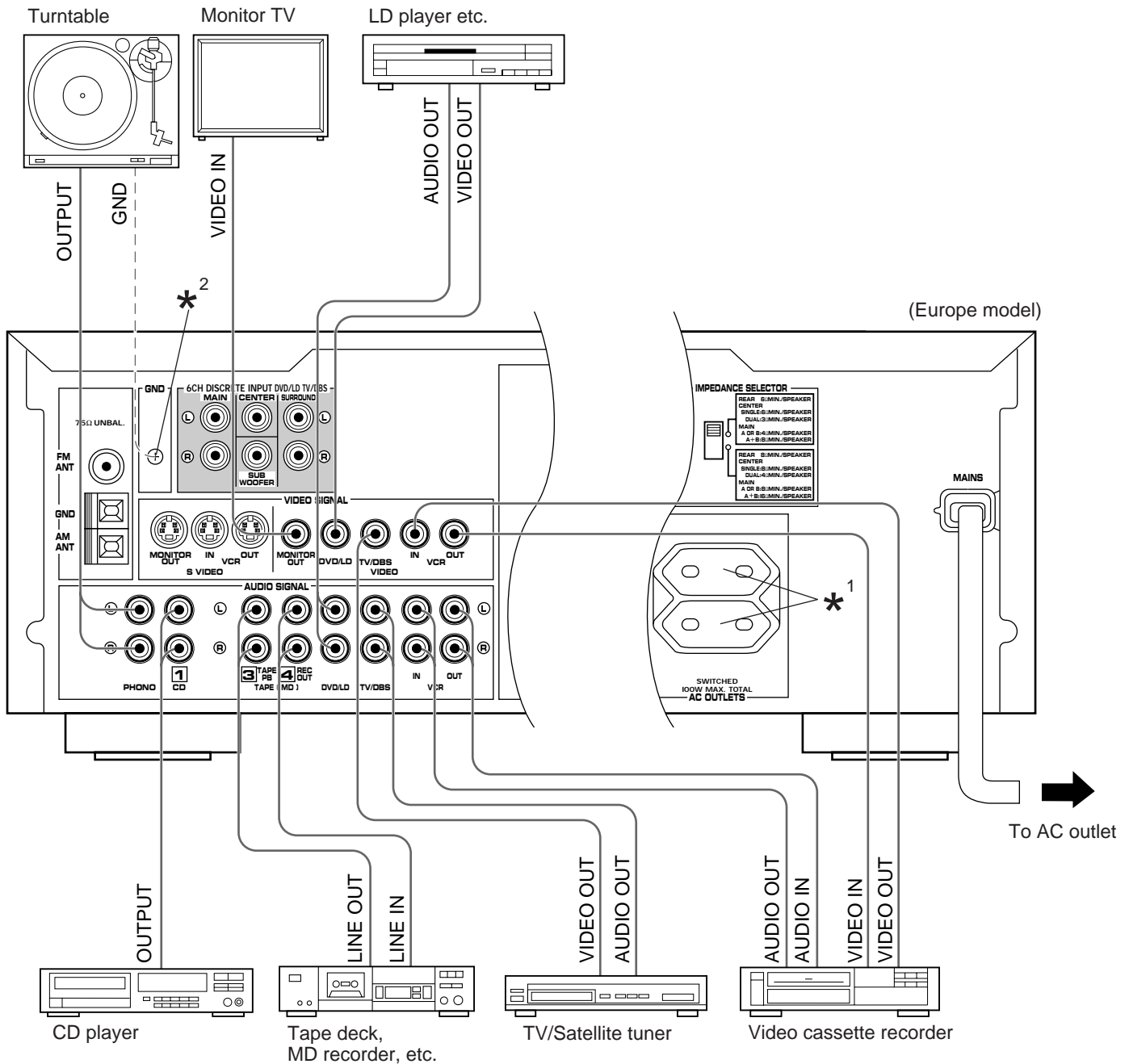

\*<sup>1</sup>, \*<sup>2</sup> : See the next page.



\*<sup>1</sup>**AC OUTLET(S) (SWITCHED)**

(Europe model) ..... 2 SWITCHED OUTLETS  
 (U.K. model) ..... 1 SWITCHED OUTLET

Use these to connect the power cords from your components to this unit.

The power to the **SWITCHED** outlets is controlled by this unit's **POWER** switch or the provided remote control transmitter's **POWER** key. These outlets will supply power to any component whenever this unit is turned on.

The maximum power (total power consumption of components) that can be connected to the **SWITCHED AC OUTLET(S)** is 100 watts.

\*<sup>2</sup>**GND terminal (For turntable use)**

Connecting the ground wire of the turntable to the **GND** terminal will normally minimize hum, but in some cases better results may be obtained with the ground wire disconnected.

**CONNECTING TO VIDEO AUX TERMINALS (ON THE FRONT PANEL)**

These terminals are used to connect any video input source such as a camcorder to this unit.

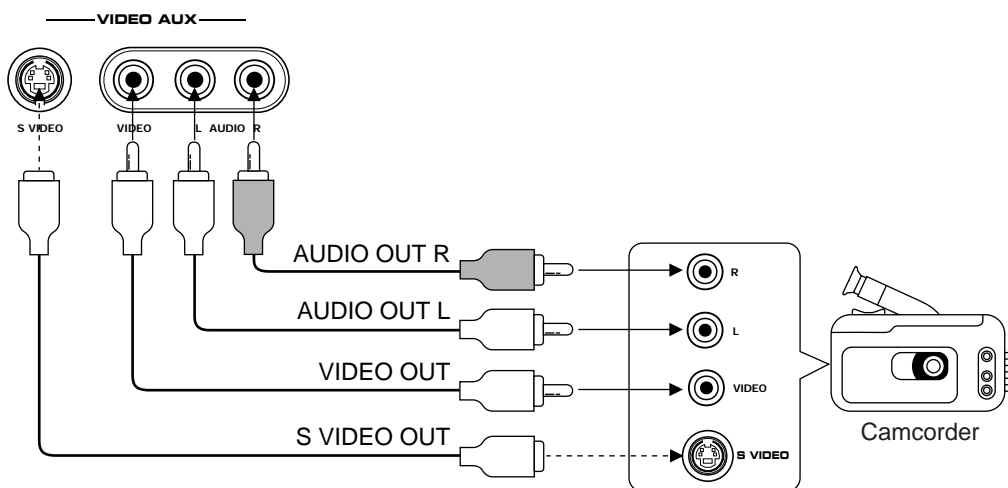

## Connecting with a Dolby Digital (AC-3) Decoder

If you have a Dolby Digital (AC-3) Decoder unit or an LD player etc. which incorporates a Dolby Digital (AC-3) Decoder, its discrete outputs can be connected to this unit.

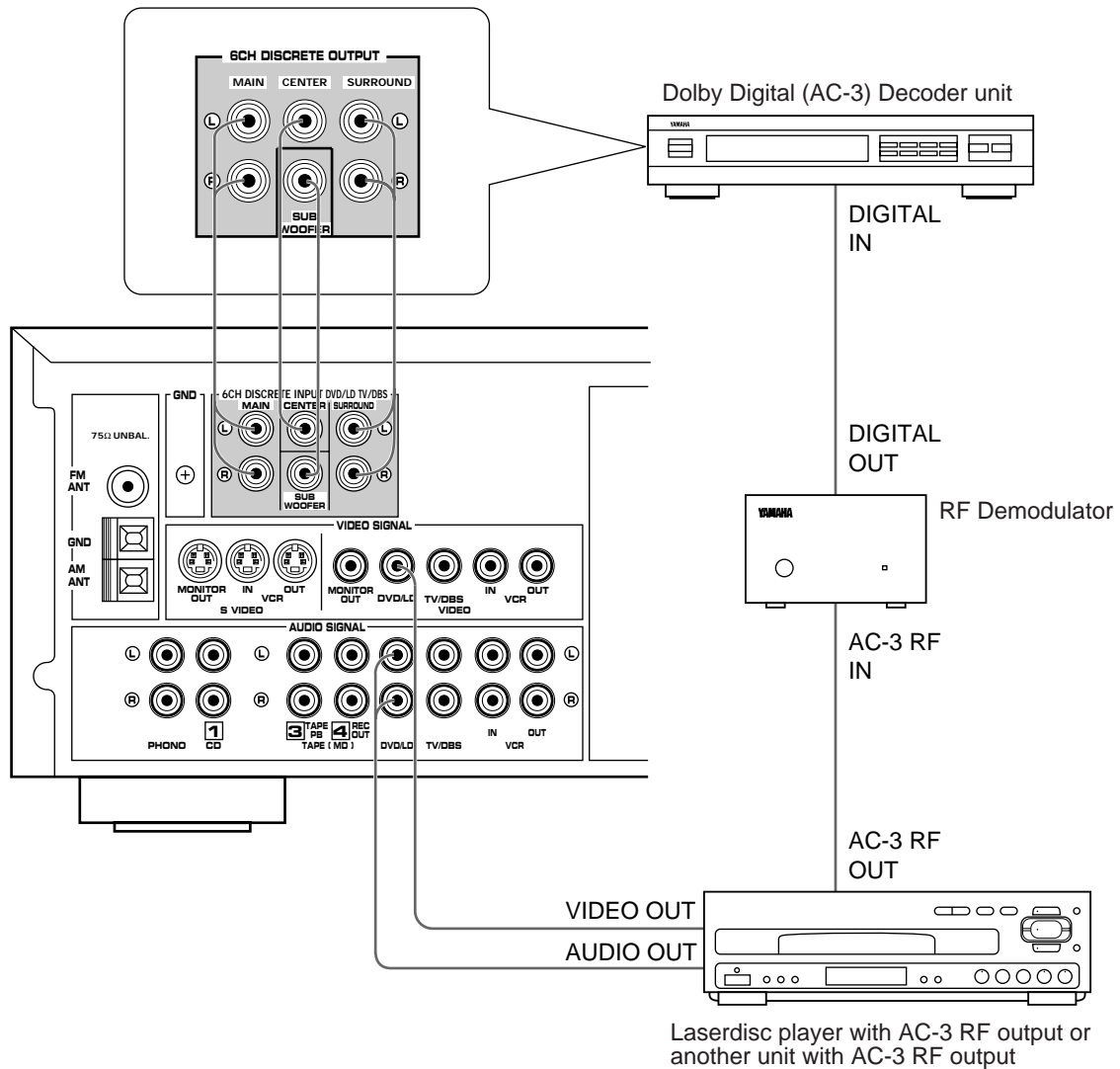

### Notes

- The laserdisc player (or another unit) must be also connected to the DVD/LD (or TV/DBS) AUDIO SIGNAL input terminals of this unit for playing a source with the Dolby Pro Logic Surround decoded or in normal stereo (or monaural).
- The discrete signals input to this unit cannot be recorded by a tape deck, MD recorder or VCR. To record a source played on the laserdisc player (or another unit), it must be connected to the DVD/LD (or TV/DBS) AUDIO/VIDEO SIGNAL input terminals of this unit.
- If you made no connection to the SUBWOOFER input terminal of this unit or you will not use a subwoofer, you should make a setting for distributing signals at the LFE channel to the right and left MAIN output terminals on the Dolby Digital (AC-3) Decoder unit. For details, refer to the owner's manual for the Dolby Digital (AC-3) Decoder unit.

## CONNECTING TO S VIDEO TERMINALS

If you have a video cassette recorder and a monitor equipped with “S” (high-resolution) video terminals, those terminals can be connected to this unit’s **S VIDEO** terminals. Connect the video cassette recorder’s “S” video input and output terminals to this unit’s **S VIDEO VCR IN** and **OUT** terminals respectively, and connect the monitor’s “S” video input terminal to this unit’s **S VIDEO MONITOR OUT** terminal. Otherwise, connect the video cassette recorder’s composite video terminals to this unit’s composite video terminals, and connect the monitor’s composite video input terminal to this unit’s composite **MONITOR OUT** terminal.

**Note**  
If video signals are sent to both **S VIDEO** input and composite input terminals, the signals will be sent to their respective output terminals independently.

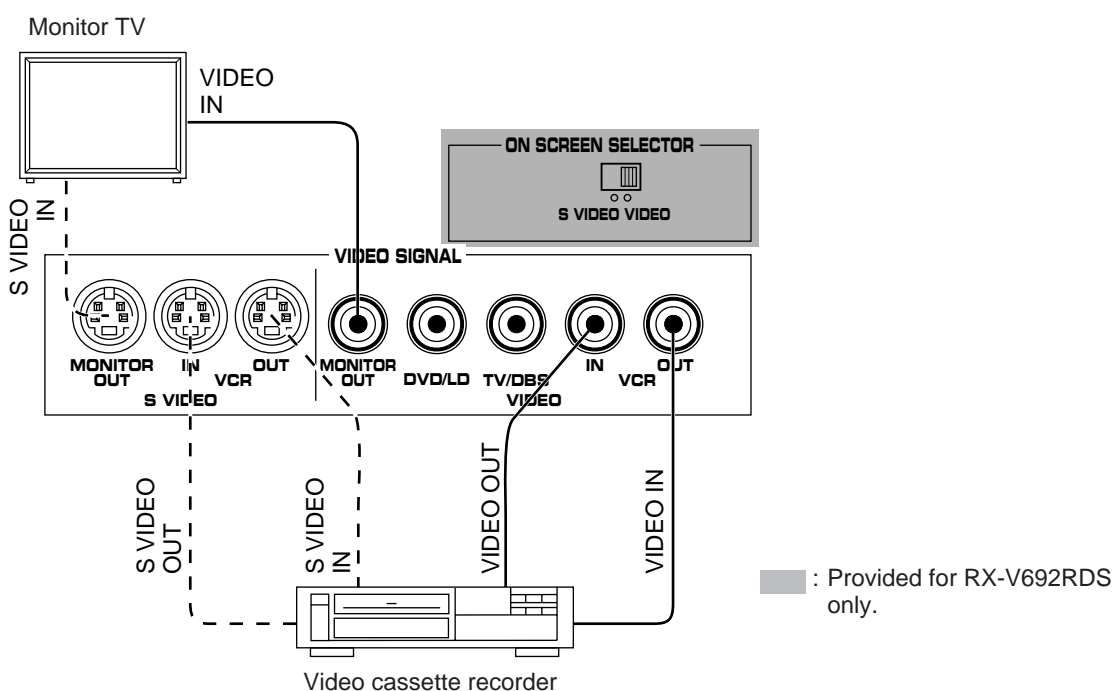

### RX-V692RDS only

## ON SCREEN DISPLAY

If you connect a video cassette recorder, LD player, video monitor, etc. to this unit, you can display DSP program names and information about other settings and adjustments on the video monitor screen which is connected to the composite **VIDEO** (or **S VIDEO**) **MONITOR OUT** terminal of this unit. Information is superimposed over the video image. If there is no program material on the monitor, the information will be displayed over a monochromatic background.

By using the **ON SCREEN SELECTOR S VIDEO/VIDEO** switch, select the video monitor connected to the **S VIDEO** or composite **VIDEO MONITOR OUT** terminal on which you want to display the screen display information.

### ON SCREEN SELECTOR S VIDEO/VIDEO switch

**S VIDEO:** In this position, the screen display information is displayed on the video monitor connected to the **S VIDEO MONITOR OUT** terminal.

**VIDEO:** In this position, the screen display information is displayed on the video monitor connected to the composite **VIDEO MONITOR OUT** terminal.

# CONNECTING SPEAKERS

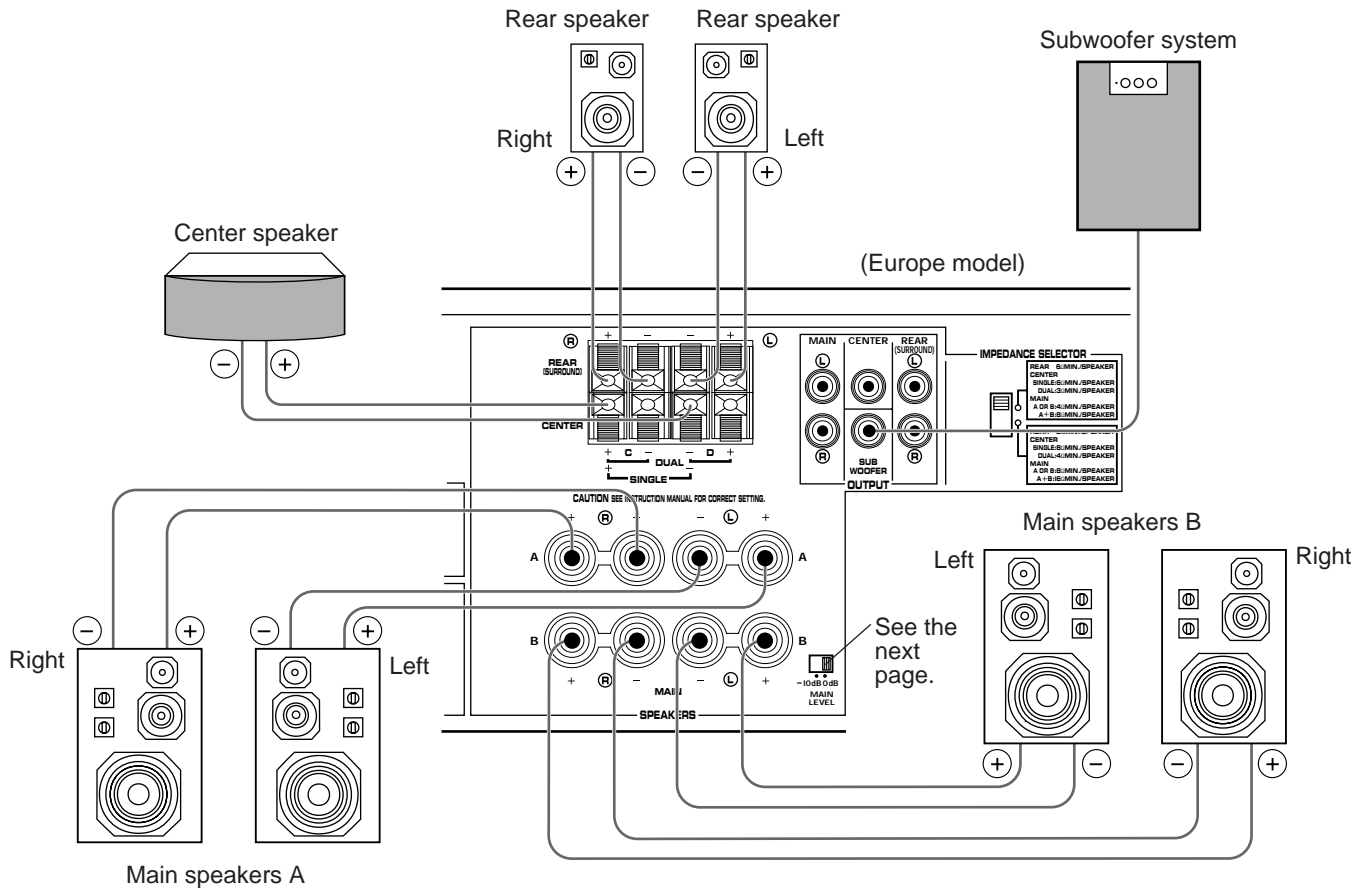

**Note**

Use speakers with the specified impedance shown on the rear of this unit.

**Note on main speaker connections:**

One or two speaker systems can be connected to this unit. If you use only one speaker system, connect it to either the **SPEAKERS A** or **B** terminals.

**Note on a subwoofer connection:**

You may wish to add a subwoofer to reinforce low frequencies or to output low bass sound from the subwoofer channel when reproducing discrete signals.

Connect the **SUBWOOFER OUTPUT** terminal of this unit to the **INPUT** terminal of the subwoofer amplifier, and connect the speaker terminals of the subwoofer amplifier to the subwoofer. With some subwoofers, including the Yamaha Active Servo Processing Subwoofer System, the amplifier and subwoofer are in the same unit.

**Note on center speaker connection:**

One or two center speakers can be connected to this unit. If you cannot place the center speaker on or under the TV, it is recommended to use two center speakers and place them on both sides of the TV to orient the center sound at the center position. For connecting two center speakers, follow the method shown below.

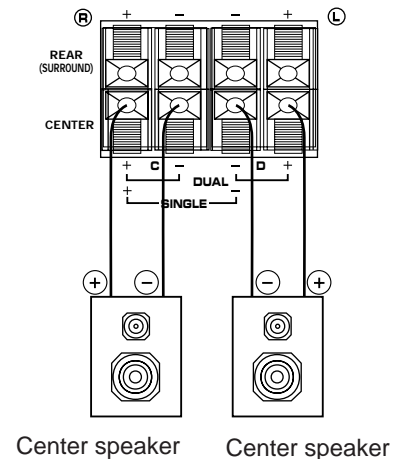

## How to Connect:

Connect the **SPEAKERS** terminals to your speakers with wire of the proper gauge, cut as short as possible. If the connections are faulty, no sound will be heard from the speakers. Make sure that the polarity of the speaker wires is correct, that is the + and – markings are observed. If these wires are reversed, the sound will be unnatural and lack bass.

### Caution

**Do not let the bare speaker wires touch each other and do not let them touch any metal part of this unit. This could damage this unit and/or speakers.**

### For connecting to the MAIN SPEAKERS terminals

Red: positive (+)  
Black: negative (-)

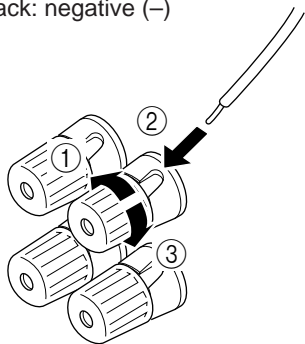

- ① Unscrew the knob.
- ② Insert the bare wire.  
[Remove approx. 5mm (1/4") insulation from the speaker wires.]
- ③ Tighten the knob and secure the wire.

### For connecting to the REAR and CENTER SPEAKERS terminals

Red: positive (+)  
Black: negative (-)

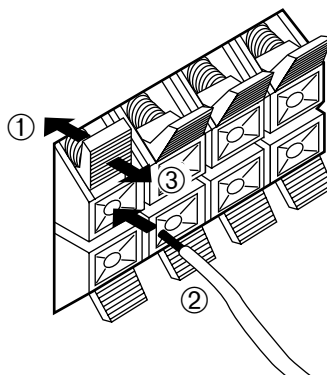

- ① Press the tab.
- ② Insert the bare wire.  
[Remove approx. 5mm (1/4") insulation from the speaker wires.]
- ③ Release the tab and secure the wire.

### MAIN LEVEL switch

Normally set to "0 dB". If desired, you can decrease the output level at the **MAIN SPEAKERS** terminals by 10 dB by setting this switch to "-10 dB".

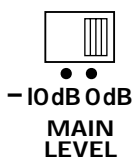

## OUTPUT terminals (for driving speakers with external amplifiers)

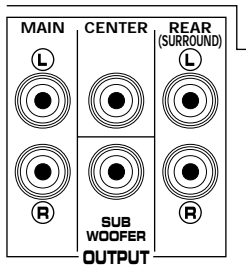

### MAIN OUTPUT terminals

These terminals are for main channel line output. There is no connection to these terminals when you use the built-in amplifier.

However, if you drive main speakers with an external stereo power amplifier, connect the input terminals of the external amplifier (MAIN IN or AUX terminals of a power amplifier or an integrated amplifier) to these terminals.

\* Output signals from the MAIN OUTPUT terminals only are affected by the use of **BASS**, **TREBLE**, **BALANCE** controls and **BASS EXTENSION** switch.

### CENTER OUTPUT terminal

This terminal is for center channel line output. There is no connection to this terminal when you use the built-in amplifier. However, if you drive a center speaker with an external power amplifier, connect the input terminal of the external amplifier to this terminal.

## IMPEDANCE SELECTOR switch

Be sure to switch this only when the power of this unit is turned off.

Select the position whose requirements your speaker system meets.

### WARNING

**Do not change the IMPEDANCE SELECTOR switch setting while the power to this unit is on, otherwise this unit may be damaged.**

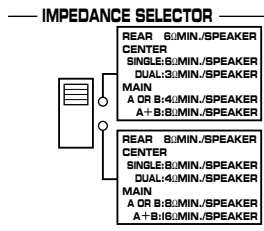

(Europe model)

### REAR (SURROUND) OUTPUT terminals

These terminals are for rear channel line output. There is no connection to these terminals when you use the built-in amplifier.

However, if you drive rear speakers with an external stereo power amplifier, connect the input terminals of the external amplifier (MAIN IN or AUX terminals of a power amplifier or an integrated amplifier) to these terminals.

### SUBWOOFER OUTPUT terminal

This terminal is for connecting with the input terminal of an amplifier for driving a subwoofer.

When the input signals to this unit are in normal 2-channel stereo, this terminal outputs only frequencies below 150 Hz from the main and center channels. When discrete signals are input to this unit and are selected as the input source, this terminal outputs signals from the subwoofer channel.

### Note

Output level of signals from all of these terminals are adjusted by the use of **VOLUME** control on the front panel or **VOLUME (MASTER VOLUME)** keys on the remote control transmitter.



(Upper position)

**Rear:** The impedance of each speaker must be 6Ω or higher.

**Center:** If you use one center speaker, the impedance of the speaker must be 6Ω or higher.  
If you use two center speakers, the impedance of each speaker must be 3Ω or higher.

**Main:** If you use one pair of main speakers, the impedance of each speaker must be 4Ω or higher.  
If you use two pairs of main speakers, the impedance of each speaker must be 8Ω or higher.



(Lower position)

**Rear:** The impedance of each speaker must be 8Ω or higher.

**Center:** If you use one center speaker, the impedance of the speaker must be 8Ω or higher.  
If you use two center speakers, the impedance of each speaker must be 4Ω or higher.

**Main:** If you use one pair of main speakers, the impedance of each speaker must be 8Ω or higher.  
If you use two pairs of main speakers, the impedance of each speaker must be 16Ω or higher.

## ANTENNA CONNECTIONS

- Each antenna should be connected to the designated terminals correctly, referring to the following diagram.
- Both AM and FM indoor antennas are included with this unit. In general, these antennas will probably provide sufficient signal strength. Nevertheless, a properly installed outdoor antenna will give clearer reception than an indoor one. If you experience poor reception quality, an outdoor antenna may result in improvement.

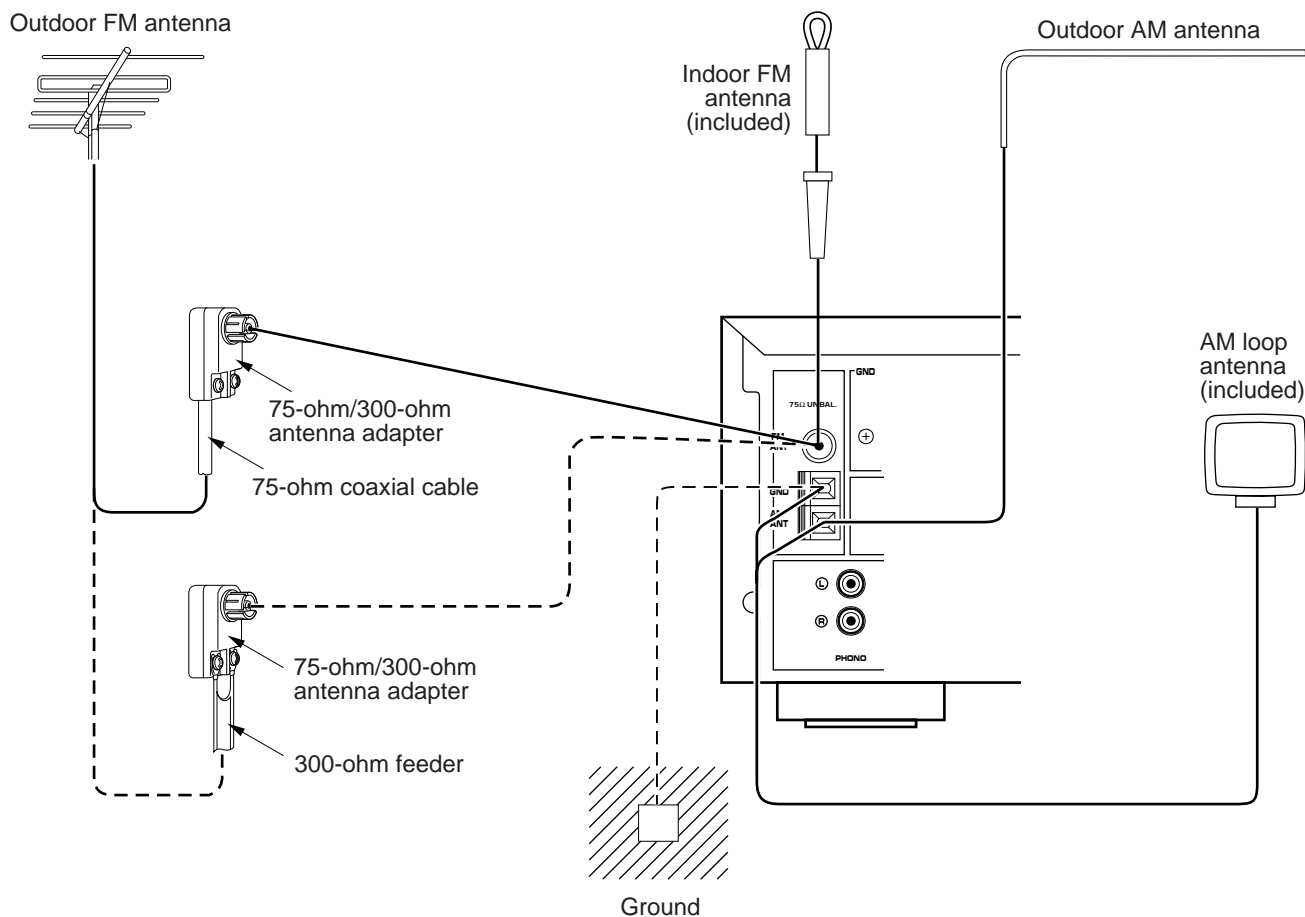

### Connecting the AM loop antenna

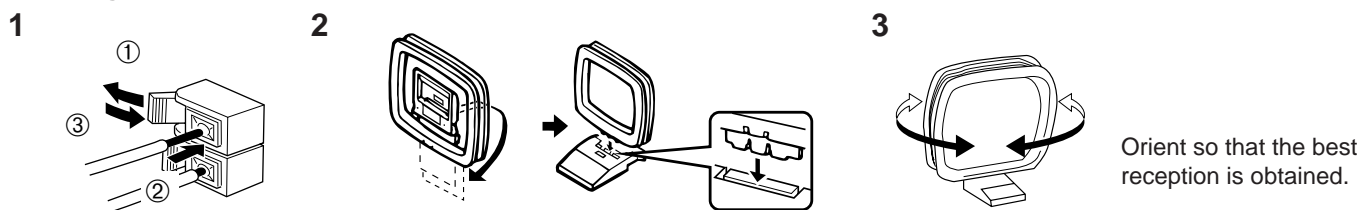

- \* The AM loop antenna should be placed apart from the main unit. The antenna may be hung on a wall.
- \* The AM loop antenna should be kept connected, even if an outdoor AM antenna is connected to this unit.

### GND terminal

For maximum safety and minimum interference, connect the **GND** terminal to a good earth ground. A good earth ground is a metal stake driven into moist earth.

### Notes

- When connecting the indoor FM antenna, insert its connector into the **FM ANT** terminal firmly.
- If you need an outdoor FM antenna to improve FM reception quality, either 300-ohm feeder or coaxial cable may be used. In locations troubled by electrical interference, coaxial cable is preferable.

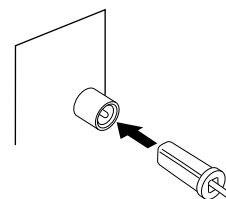

# CONTROLS AND THEIR FUNCTIONS

## FRONT PANEL

### RX-V692RDS

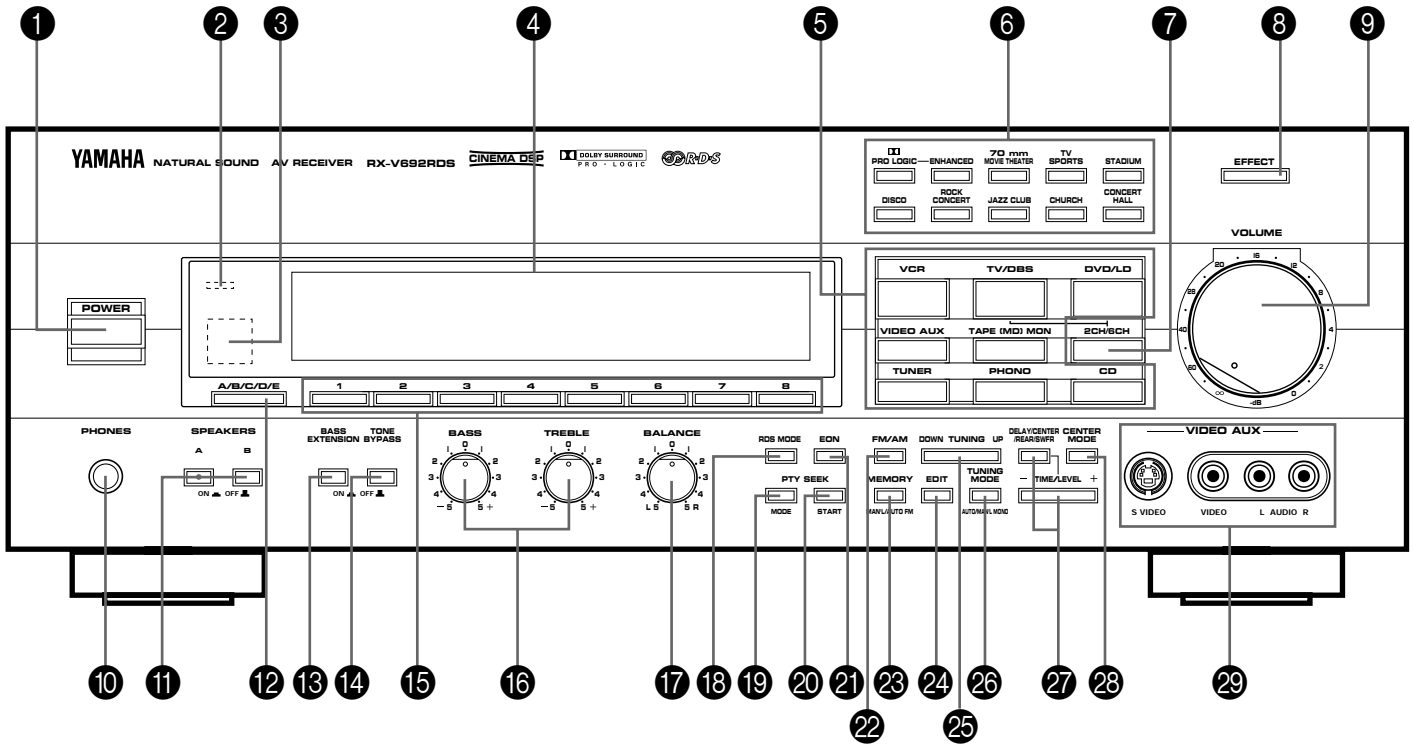

### RX-V592RDS

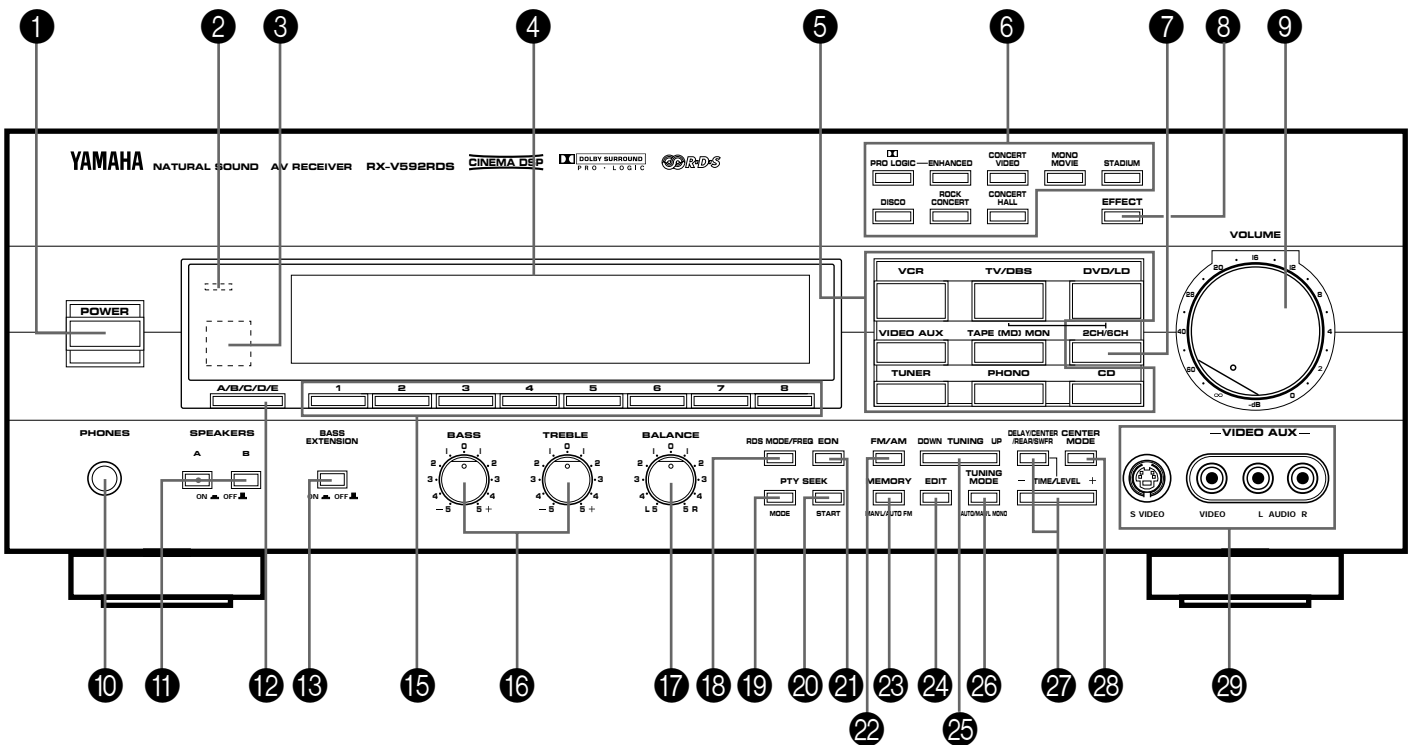



**1 POWER switch**

Press this switch to switch the power on. Press it again to switch the power off.

**2 Standby mode indicator**

While the power is on, pressing the **POWER (SYSTEM POWER OFF)** key on the remote control transmitter switches the unit to the standby mode. In this mode, this indicator is illuminated.

**3 Remote control sensor**

Receives signals from the remote control transmitter.

**4 Display panel**

Shows various information. (Refer to page 19–20 for details.)

**5 Input selector buttons**

Select a program source to listen to or watch. When a button is pressed, the name of selected source appears on the display.

**6 DSP program selector buttons**

Select a DSP program. When a button is pressed, the name of selected program lights up on the display.

**7 2CH/6CH selector button**

When the **TV/DBS** or **DVD/LD** input source is selected, pressing this button switches the input signals between 2 channel stereo signals and 6 channel discrete signals. When switched to “6CH”, discrete signals from the unit connected to the 6CH DISCRETE INPUT DVD/LD TV/DBS terminals of this unit are selected as the input signals.

**8 EFFECT button**

Switches on/off the digital sound field processor (including the Dolby Pro Logic Surround decoder).

**9 VOLUME control**

Used to raise or lower the volume level.

**10 PHONES jack**

When you listen with headphones, connect the headphones to the **PHONES** jack. You can listen to the sound to be output from the main speakers through headphones.

When listening with headphones privately, set both the **SPEAKERS A** and **B** switches to the **OFF** position and switch off the digital sound field processor (so that no DSP program name is illuminated on the display) by pressing the **EFFECT** button.

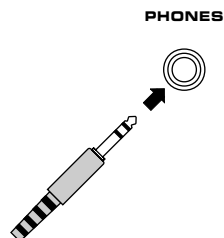
**11 SPEAKERS switches**

Set the switch **A** or **B** (or both **A** and **B**) for the main speaker system (connected to this unit) you will use to the **ON** position. Set the switch for the main speaker system you will not use to the **OFF** position.

**12 A/B/C/D/E button**

Press this button to select a desired group (A–E) of preset stations.

**13 BASS EXTENSION switch**

When this switch is pressed inward (ON), boosts bass frequency response at the main left and main right channels while maintaining overall tonal balance. If you do not have a subwoofer, the use of this switch will be effective to reinforce the bass frequencies.

**14 TONE BYPASS switch****RX-V692RDS only**

When this switch is pressed inward (ON), the input signal does not pass through the tone control circuitry so that it is unaffected by the tone control circuitry. Use this switch to obtain pure sound and to check the tone control setting. Press this switch to release it outward (OFF) to use the tone control circuitry.

**15 Preset station number selector buttons**

Select a preset station number (1 to 8).

**16 Tone controls**

These controls are effective only for the sound from the main speakers.

**BASS**

Used to increase or decrease the low frequency response. The 0 position produces flat response.

**TREBLE**

Used to increase or decrease the high frequency response. The 0 position produces flat response.

**17 BALANCE control**

Adjusts the balance of the output volume to the left and right speakers to compensate for sound imbalance caused by speaker location or listening room conditions.

**18 RDS MODE button** **RX-V692RDS**

When an RDS station is received, pressing this button changes the display mode into the PS mode, PTY mode, RT mode and/or CT mode (if the station employs those RDS data services) in turn.

**RDS MODE/FREQ button** **RX-V592RDS**

When an RDS station is received, pressing this button changes the display mode into the PS mode, PTY mode, RT mode and/or CT mode (if the station employs those RDS data services), and frequency display in turn.

**19 PTY SEEK MODE button**

When this button is pressed, the unit turns into the PTY SEEK mode.

**20 PTY SEEK START button**

Press this button to begin searching for a station after the desired program type is selected in the PTY SEEK mode.

**21 EON button**

Press this button to select a desired program type (NEWS, INFO, AFFAIRS, SPORT) when you want to call a radio program of that program type automatically.

**22 FM/AM buttons**

Press this button to switch the reception band to FM or AM.

**23 MEMORY (MAN'L/AUTO FM) button**

When this button is pressed, the MEMORY indicator flashes for about 5 seconds. During this period, select a desired preset station number by pressing the corresponding preset station number selector button to enter the displayed station into the memory.

When this button is pressed and held for about 3 seconds, the automatic preset tuning begins. (Refer to page 30 for details.)

**24 EDIT button**

This button is used to exchange the places of two preset stations with each other.

**25 TUNING DOWN/UP button**

Used for tuning. Press the "UP" side to tune in to higher frequencies, and press the "DOWN" side to tune in to lower frequencies.

When this unit is in the PTY SEEK mode, pressing this switch changes the currently selected program type.

**26 TUNING MODE (AUTO/MAN'L MONO) button**

Press this button to switch the tuning mode to automatic or manual. To select the automatic tuning mode, press this button so that "AUTO (TUNING)" lights up on the display. To select the manual tuning mode, press this button so that "AUTO (TUNING)" goes off.

**27 DELAY/CENTER/REAR/SWFR and TIME/LEVEL +/- buttons**

Adjust the delay time (DELAY), the center channel output level (CENTER), the rear channel output level (REAR) and the output level to the SUBWOOFER OUTPUT terminal (SWFR). Select the item which you want to adjust by pressing the DELAY/CENTER/REAR/SWFR button and adjust its time or level by pressing the TIME/LEVEL +/- button.

**28 CENTER MODE button**

Selects a center channel output mode (NORMAL, WIDE or PHANTOM). (For details, refer to page 23.)

**29 VIDEO AUX terminals**

Connect an auxiliary video or audio input source unit such as a camcorder to these terminals. If the connected video unit has a S video output terminal, connect it to the S VIDEO terminal to obtain a high resolution picture. The source connected to these terminals can be selected by the corresponding input selector button.

## DISPLAY PANEL

### RX-V692RDS

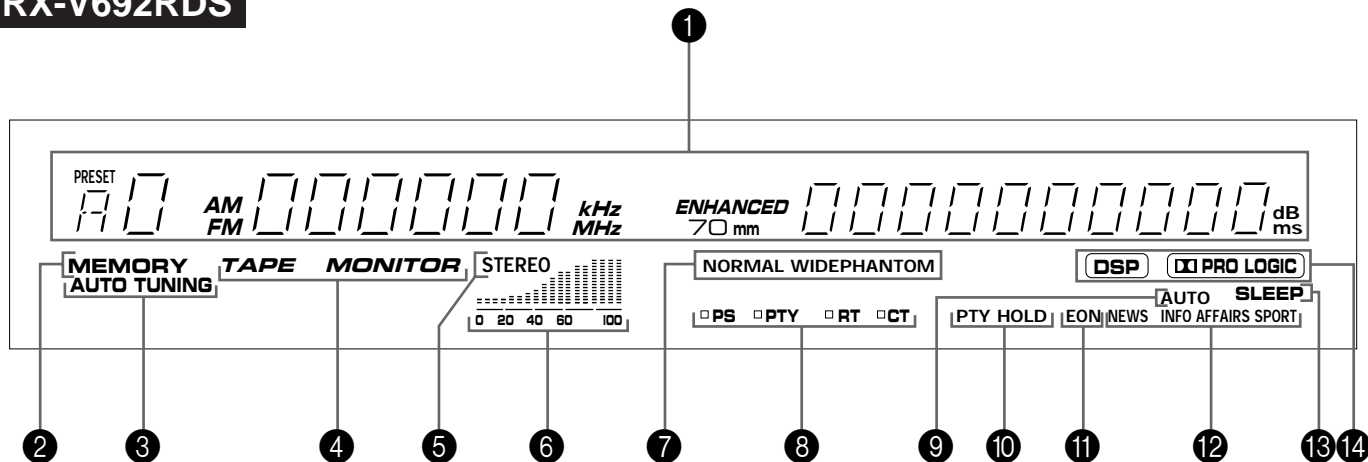

### RX-V592RDS

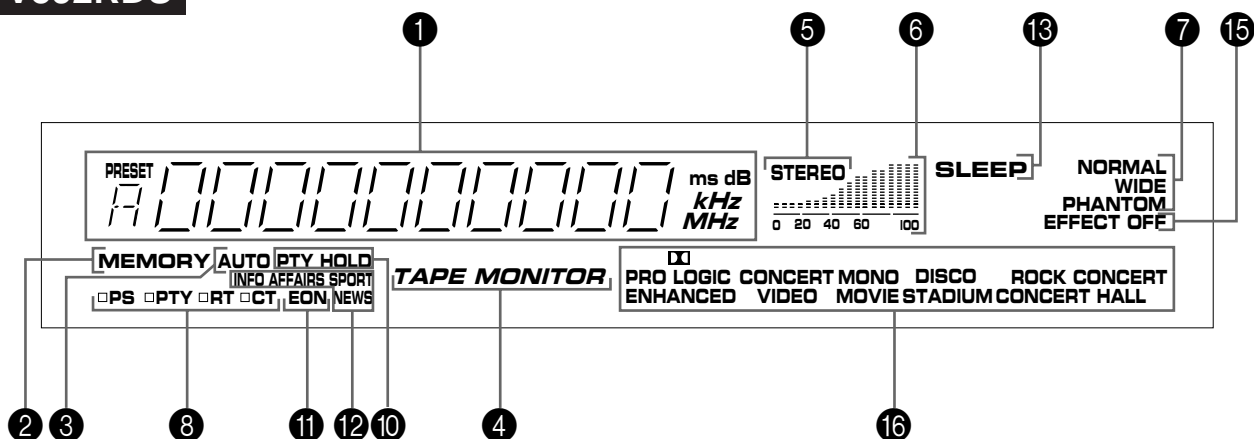

#### 1 Multi-information display

Displays various information, for example station frequency, preset station number and name of selected input source.

#### 2 MEMORY indicator

When the **MEMORY** button is pressed, this indicator flashes for about 5 seconds. During this period, the displayed station can be programmed to the memory by using the **A/B/C/D/E** button and the preset station number selector buttons.

#### 3 AUTO (TUNING) indicator

Lights up when this unit is in the automatic tuning mode.

#### 4 TAPE MONITOR indicator

Lights up when the tape deck (or MD recorder etc.) is selected as the input source by pressing the **TAPE (MD) MON** button.

#### 5 STEREO indicator

Lights up when an FM stereo broadcast with sufficient signal strength is received.

#### 6 Signal-level meter

Indicates the signal level of the received station. If multipath interference is detected, the indication decreases.

#### 7 Center channel mode indicators

The name of a selected center channel mode lights up only when a program which uses the Dolby Pro Logic Surround decoder is selected.

#### 8 RDS mode indicators

The name(s) of RDS mode(s) employed by the currently received RDS station light(s) up. Illumination of the indicator on the head of a name shows that the corresponding RDS mode is now selected.

#### 9 AUTO indicator **RX-V692RDS only**

Flashes while the search is performed in the PTY SEEK mode.

**10 PTY HOLD indicator**

Lights up while the search is performed in the PTY SEEK mode.

**11 EON indicator**

Lights up when an RDS station that employs the EON data service is received.

**12 Program type name indicators**

The name selected in the EON mode lights up.

**13 SLEEP indicator**

Lights up while the built-in SLEEP timer is functioning.

**14 DSP and PRO LOGIC indicators**

**RX-V692RDS only**

“DSP” lights up when the built-in digital sound field processor is on, and “PRO LOGIC” lights up when the built-in Dolby Pro Logic Surround decoder is on. Both indicators light up when the digital sound field processor and the Dolby Pro Logic Surround decoder are on.

**15 EFFECT OFF indicator RX-V592RDS only**

Lights up if neither the digital sound field processor nor the Dolby Pro Logic Surround decoder is on. In this state, sound output is 2-channel stereo.

**16 DSP program indicators RX-V592RDS only**

The name of a selected DSP program lights up when the built-in digital sound field processor and/or the Dolby Pro Logic Surround decoder is on.

## REMOTE CONTROL TRANSMITTER

### RX-V592RDS only

\* For the remote control transmitter of RX-V692RDS, see page 43–52.

The remote control transmitter provided with this unit is designed to control all the most commonly used functions of this unit. If the CD player and tape deck connected to this unit are YAMAHA components designed for remote control compatibility, then this remote control transmitter will also control various functions of each component.

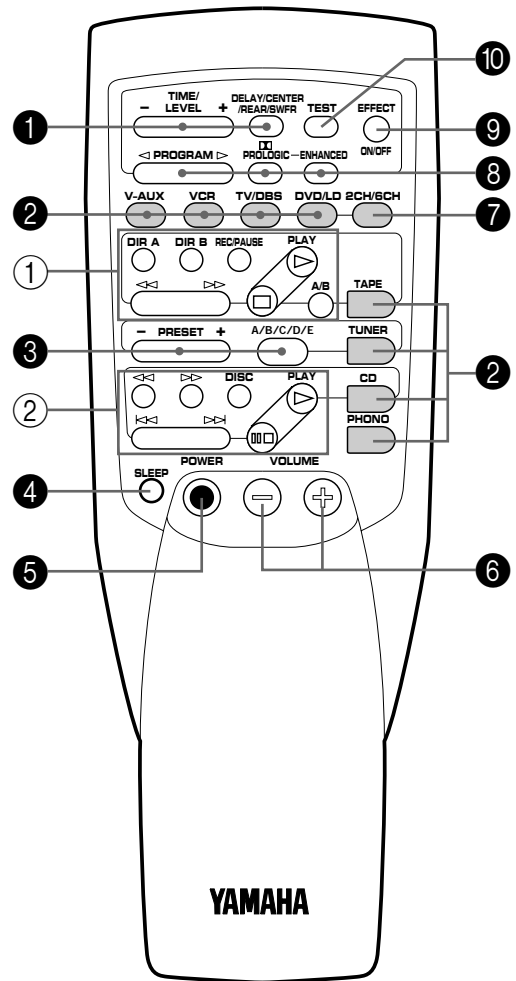

## For Control of This Unit

### ① DELAY/CENTER/REAR/SWFR and TIME/LEVEL +/- keys

Adjust the delay time (DELAY), the center channel output level (CENTER), the rear channel output level (REAR) and the output level to the SUBWOOFER OUTPUT terminal (SWFR).

Select the item which you want to adjust by pressing the **DELAY/CENTER/REAR/SWFR** key and adjust its time or level by pressing the **TIME/LEVEL +/-** key.

### ② Input selector keys

Selects input source.

### ③ Tuner keys

Controls tuner.

**+**: Selects higher preset station number.

**-**: Selects lower preset station number.

**A/B/C/D/E**: Selects the group (A – E) of preset station numbers.

### ④ SLEEP timer key

This key is used to turn the built-in SLEEP timer on and off, and to set the SLEEP time. (See page 42 for details.)

### ⑤ POWER key

Turns the power on/off.

\* While the power is on, pressing the **POWER** key on the remote control transmitter switches the unit from the power-on mode to the standby mode, and vice versa. (In the standby mode, the standby mode indicator on the front panel is illuminated.)

### ⑥ VOLUME +/- keys

Turns the volume level up/down.

### ⑦ 2CH/6CH selector key

When the **TV/DBS** or **DVD/LD** input source is selected, pressing this key switches the input signals between 2 channel stereo signals and 6 channel discrete signals. When switched to "6CH", discrete signals from the unit connected to the 6CH DISCRETE INPUT DVD/LD TV/DBS terminals of this unit are selected as the input signals.

### ⑧ Program selector keys

#### PROGRAM:

When the built-in digital sound field processor (including the Dolby Pro Logic Surround decoder) is on, this key changes the currently selected DSP program whenever the right or left side of this key is pressed.

#### PROLOGIC:

Directly selects the **PRO LOGIC** program.

#### ENHANCED:

Directly selects the **PRO LOGIC ENHANCED** program.

### ⑨ EFFECT ON/OFF key

Switches on/off the digital sound field processor (including the Dolby Pro Logic Surround decoder).

### ⑩ TEST key

Used for speaker balance adjustment. (For details, refer to page 22–24.)

## For Other Component Control

Identify the remote control transmitter keys with your component's keys. If these keys are identical, their functions will be the same. On each key function, refer to the corresponding instruction on your component's manual.

### ① Tape deck keys

Controls tape deck.

\* **DIR A, B** and **A/B** are applicable only to double cassette tape deck.

\* For a single cassette deck with automatic reverse function, pressing **DIR A** will reverse the direction of tape running.

### ② CD player keys

Controls compact disc player.

\* **DISC** is applicable only to compact disc changer.

# SPEAKER BALANCE ADJUSTMENT

This procedure lets you adjust the sound output level balance between the main, center, and rear speakers using the built-in test tone generator. When this adjustment is performed, the sound output level heard at the listening position will be the same from each speaker. This is important for the best performance of the digital sound field processor and the Dolby Pro Logic Surround decoder.

The adjustment of each speaker output level should be done at your listening position with the remote control transmitter. Otherwise, the result may not be satisfactory.

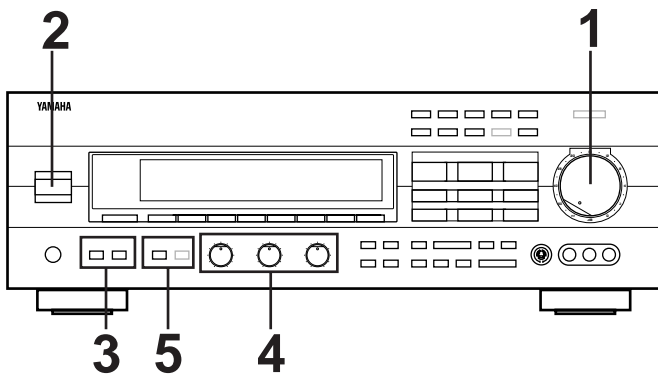

 : Provided for RX-V692RDS only.

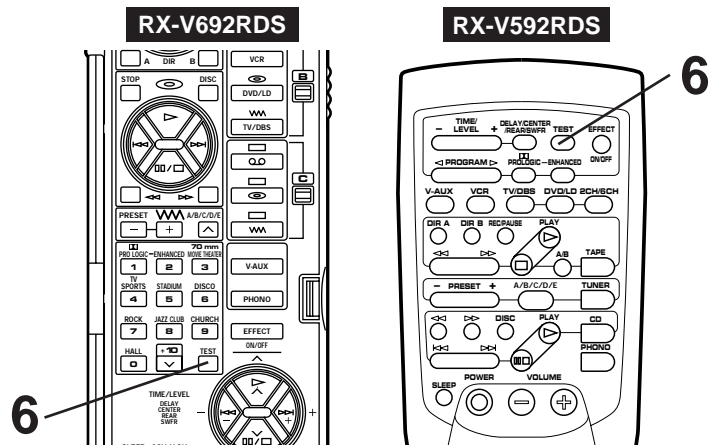

**1**

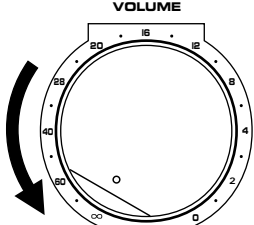

Set to the "∞" position.

---

**2** Turn the power on.

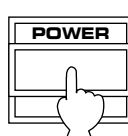



---

**3** Select the main speakers to be used.

**SPEAKERS**

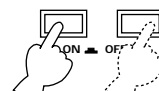
A      B



\* If you use two main speaker systems, press both the A and B switches.

**4**

**BASS**



**TREBLE**



**BALANCE**



Set to the "0" position.

---

**5**

**RX-V692RDS**

**BASS    TONE  
EXTENSION BYPASS**

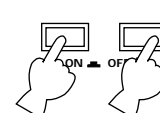

**RX-V592RDS**

**BASS  
EXTENSION**

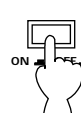

Set to the "OFF (  )".

---

**6**

**RX-V692RDS**

**TEST**



**RX-V592RDS**

**TEST**



→ TEST LEFT

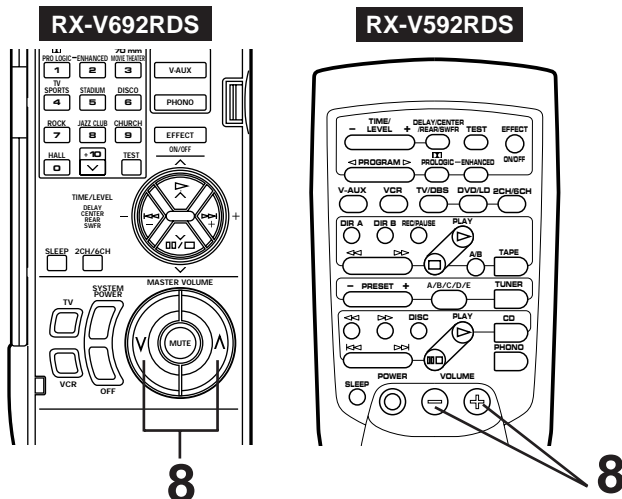
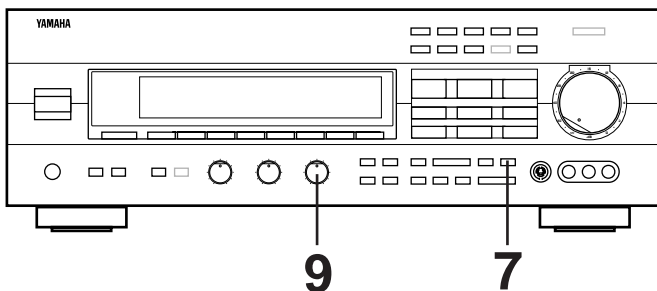

**7** Select the center channel output mode suitable for your speaker configuration.  
(Refer to "SPEAKER CONFIGURATION" on page 7.)

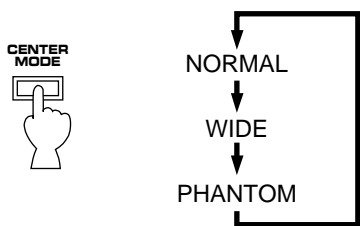

On the feature of each mode, refer to the "Note" shown below.

**Note**  
In step 7, when you select a center channel output mode, note the following.

**For 5-speaker configuration)**

**NORMAL:** Select this mode when you use a center speaker that is smaller than the main speakers. In this mode, the bass tone will be output from the main speakers.

**WIDE:** Select this mode when you use the center speaker approximately same sized as the main speakers.

**For 4-speaker configuration)**

**PHANTOM:** Select this mode when you do not use the center speaker. The center sound will be output from the left and right main speakers.

**8** Turn up the volume.

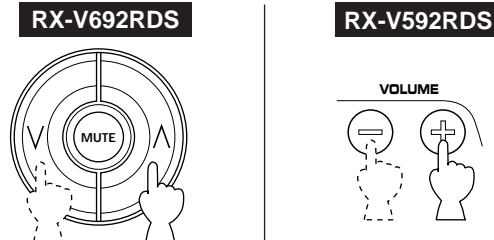

You will hear a test tone (like pink noise) from the left main speaker, then the center speaker, then the right main speaker, and then the rear speakers, for about two seconds each. The display changes as shown below.

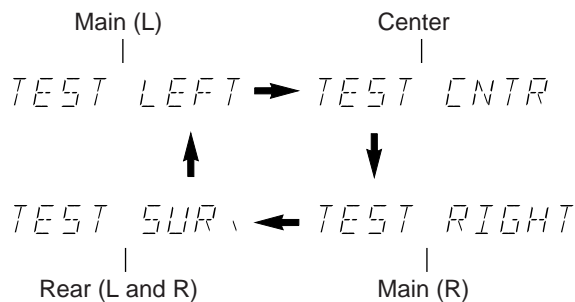

\* The test tone from the left rear speaker and the right rear speaker will be heard at the same time.

**9** Adjust the **BALANCE** control so that the effect sound output level of the left main speaker and the right main speaker are the same.



**CONTINUED**

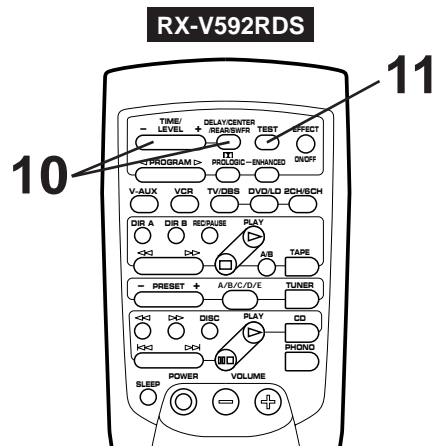
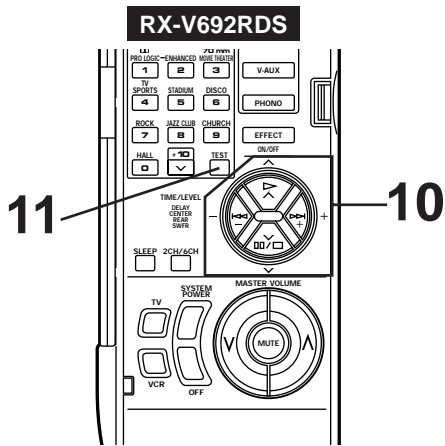

**10** Adjust the sound output levels of the center speaker and the rear speakers so that they become almost as same as that of the main speakers.

- a) Press once or more so that "CENTER" or "REAR" appears on the display.  
 \* Select "CENTER" to adjust the output level of the center speaker, and select "REAR" to adjust the output level of the rear speakers.

**RX-V692RDS**

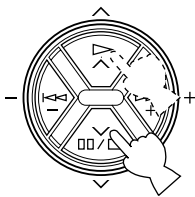

**RX-V592RDS**



- b) Adjust its level.  
 \* Pressing the + side raises and the - side lowers the level.

**RX-V692RDS**

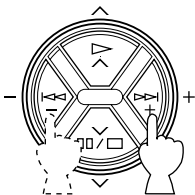

**RX-V592RDS**

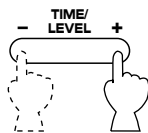

**11** Cancel the test tone.

**RX-V692RDS**



**RX-V592RDS**



→ TEST LEFT  
 Disappears.

**Notes**

- Once you have completed these adjustments, you can adjust whole sound level on your audio system by using the **VOLUME** control (or the **VOLUME (MASTER VOLUME)** keys on the remote control transmitter) only.
- If you use external power amplifiers, you may also use their volume controls to achieve proper balance.
- In step 10, if the center channel mode is in the "PHANTOM" position, the sound output level of the center speaker cannot be adjusted. This is because in this mode, the center sound is automatically output from the left and right main speakers.
- If there is insufficient sound output from the center and rear speakers, you may decrease the main speaker output level by setting the **MAIN LEVEL** switch on the rear panel to "-10 dB".



# BASIC OPERATIONS

## TO PLAY A SOURCE

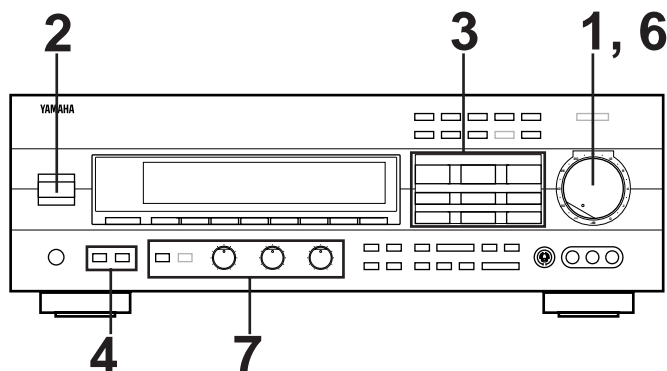

 : Provided for RX-V692RDS only.

### 1

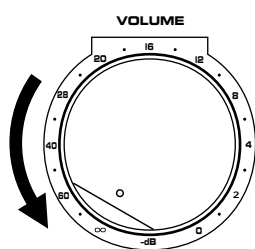

Set to the "∞" position.

### 2

Turn the power on.

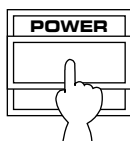

### 3

Select the desired input source by using the input selector buttons.  
(For video sources, turn the TV/monitor ON.)

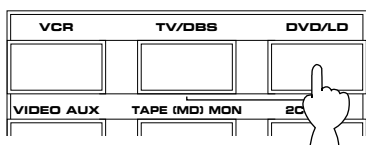

\* The name of the selected input source will appear on the display.

### 4

Select the main speakers to be used.

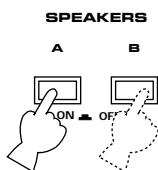

\* If you use two main speaker systems, press both the A and B switches.

### 5

Play the source. (For detailed information on the tuning operation, refer to page 28.)

### 6

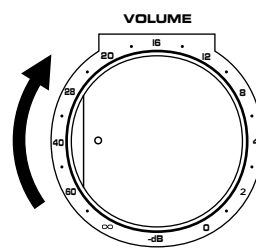

Adjust to the desired output level.

### 7

If desired, adjust the **BASS, TREBLE, BALANCE** controls, etc. (refer to page 27) and use the digital sound field processor. (Refer to page 39.)

#### Notes on using the input selector buttons

- Note that pressing on each input selector button selects the source which is connected to the corresponding input terminals on the rear panel.
  - \* To select the source connected to the **VIDEO AUX** terminals on the front panel, press **VIDEO AUX**.
- The selection of **TAPE (MD) MON** cannot be canceled by pressing another input selector button. To cancel it, press **TAPE (MD) MON** again so that "TAPE MONITOR" disappears from the display.
  - When you select a button other than **TAPE (MD) MON**, make sure that "TAPE MONITOR" is not illuminated on the display.
- If you select the input selector button for a video source without canceling the selection of **TAPE (MD) MON**, the playback result will be the video image from the video source and the sound from the audio tape (or MD etc.).
- Once you play a video source, its video image will not be interrupted even if the input selector button for an audio source is selected.

#### To turn off the power

Press the **POWER** switch again.

To listen to a decoded source using Dolby Digital (AC-3) by reproducing the signals input to the 6CH DISCRETE INPUT DVD/LD TV/DBS terminals of this unit.

In step 3, select TV/DBS or DVD/LD, and then press the 2CH/6CH button so that "6ch" appears on the display. Discrete signals from the unit connected to the 6CH DISCRETE INPUT DVD/LD TV/DBS terminals of this unit are selected as the input signals.



To cancel it, press the 2CH/6CH button again or select another input source.

**Note for reproducing discrete signals with Dolby Digital (AC-3) decoded:**

1. Your speaker system must include a center speaker.
2. Your speaker system must include a subwoofer.
  - \* Connect a subwoofer which has a built-in amplifier to the SUBWOOFER OUTPUT terminal of this unit.
  - \* You can do without using a subwoofer. If you do so, you should make a setting for distributing signals at the LFE channel to the right and left MAIN output terminals on the Dolby Digital (AC-3) Decoder unit. For details, refer to the owner's manual for the Dolby Digital (AC-3) Decoder unit.

**Notes**

- When you switch to the "6CH" mode, the built-in Digital Sound Field processor will not work and adjustment of delay time cannot be made.
- Switching this unit to the "6CH" mode will input no signal to this unit if there is no connection to the 6CH DISCRETE INPUT DVD/LD TV/DBS terminals of this unit.

**TO RECORD A SOURCE TO TAPE (OR MD)**

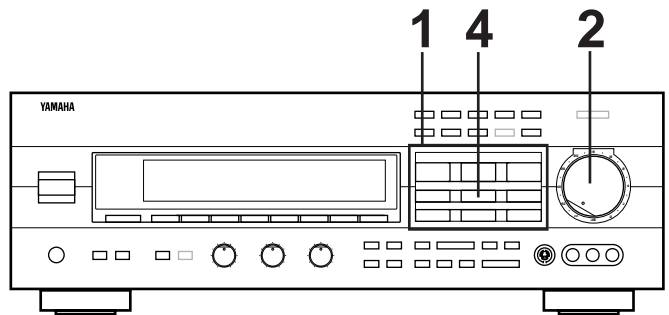

**1** Select the source to be recorded.

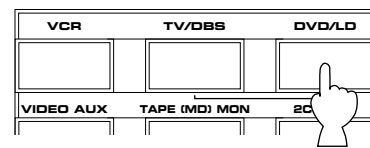

**2** Play the source and then turn the **VOLUME** control up to confirm the input source. (For detailed information on the tuning operations, refer to the page 28.)

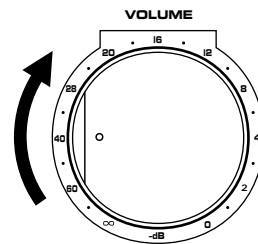

**3** Begin recording on the tape deck (or MD recorder etc.) or VCR connected to this unit.

**4** If the tape deck (or MD recorder etc.) is used for recording, you can monitor the sounds being recorded by pressing **TAPE (MD) MON** so that "TAPE MONITOR" lights up on the display.

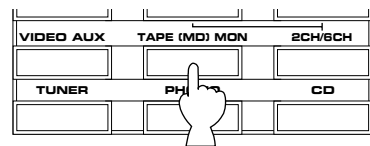

**Notes**

- The settings of DSP and the **VOLUME, BASS, TREBLE, BALANCE** controls and the **BASS EXTENSION** switch have no effect on the material being recorded.
- In step 1, do not make an input source selection so that "6ch" appears on the display. Signals input to this unit's 6CH DISCRETE INPUT DVD/LD TV/DBS terminals cannot be recorded by a tape deck, MD recorder or VCR.

## Selecting the SPEAKER system

Because one or two speaker systems (as main speakers) can be connected to this unit, the **SPEAKERS** switches allow you to select speaker system **A** or **B**, or both at once.

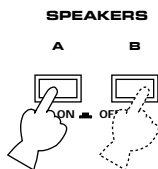

## Adjusting the BALANCE control

Adjust the balance of the output volume to the left and right speakers to compensate for sound imbalance caused by speaker location or listening room conditions.



### Note

This control is effective only for the sound from the main speakers.

## Adjusting the BASS and TREBLE controls

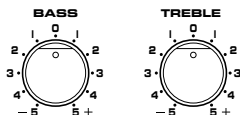

**BASS** : Turn this clockwise to increase (or counter-clockwise to decrease) the low frequency response.

**TREBLE** : Turn this clockwise to increase (or counter-clockwise to decrease) the high frequency response.

### Note

These controls are effective only for the sound from the main speakers.

## Using the BASS EXTENSION switch

You can boost bass frequency response by setting this switch to the "ON" position. This switch is effective only on the sound from the main speakers.

### RX-V692RDS

BASS TON  
EXTENSION BYPA

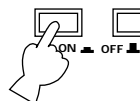

### RX-V592RDS

BASS  
EXTENSION

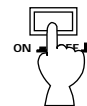

## Using the TONE BYPASS switch

### RX-V692RDS only

Press this switch to revert instantly to the flat states of the **BASS** and **TREBLE** controls without changing the setting of these controls.

BASS TONE  
EXTENSION BYPASS

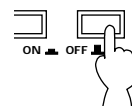

# TUNING OPERATIONS

Normally, if station signals are strong and there is no interference, quick automatic-search tuning (AUTOMATIC TUNING) is possible. However, if signals of the station you want to select are weak, you must tune to it manually (MANUAL TUNING).

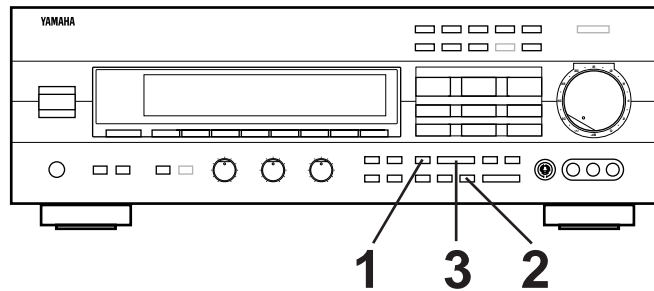

## AUTOMATIC TUNING

**1** Select the reception band (FM or AM) confirming it on the display.

**2**

**3**

To tune to a higher frequency, press the right side once.  
To tune to a lower frequency, press the left side once.

- \* If the station where tuning search stops is not the desired one, press again.
- \* If the tuning search does not stop at the desired station (because the signals of the station are weak), change to the MANUAL TUNING method.

## MANUAL TUNING

**1** Select the reception band (FM or AM) confirming it on the display.

**2**

**3** Tune to a desired station manually.

\* To continue tuning search, press and hold the button.

### Notes

- If you tune to an FM station manually, it is received in monaural mode automatically to increase the signal quality.
- **RX-V692RDS only**  
If an RDS station that employs PS data service is received, its station name is shown on the display.
- **RX-V592RDS only**  
When tuned in to a station, the frequency of the received station is shown on the display. If an RDS station that employs PS data service is received, the frequency is then replaced by the station name. Refer to page 34 for details.

# PRESET TUNING

## MANUAL PRESET TUNING

This unit can store station frequencies selected by tuning operation. With this function, you can recall any desired station by only selecting the preset station number where it is stored. Up to 40 stations (8 stations x 5 groups) can be stored.

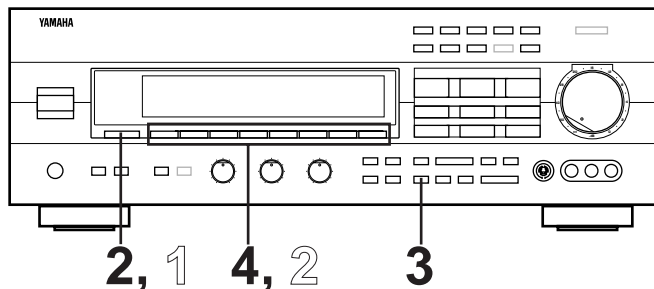

### To store stations

- 1 Tune to a desired station.  
(Refer to the previous page for tuning procedure.)
- 2 Select a desired group (A – E) of preset stations confirming it on the display.
- 3 

Flashes on and off for about 5 seconds.
- 4 Select a preset station number where you want to program the station before "MEMORY" goes off from the display.  

Shows the displayed station has been programmed to A1.

\* In the same way, program other stations to A2, A3 ... A8.  
 \* You can program more stations to preset station numbers on other groups in the same way by selecting other groups in step 2.

### To recall a preset station

- 1 Select the group of preset stations.
- 2 Select the preset station number.

- Notes**
- A new setting can be programmed in place of the former one.
  - For presets, the setting of the reception mode (stereo or monaural) is stored along with the station frequency.

**Memory back-up**  
 The memory back-up circuit prevents the programmed data from being lost even if the **POWER** switch is set off or the power plug is disconnected from the AC outlet or the power is cut due to temporary power failure. If, however, the power is cut for more than one week, the memory may be erased. If so, it can be re-programmed by simply following the PRESET TUNING steps.



## AUTOMATIC PRESET TUNING

You can also make use of an automatic preset tuning function for RDS stations only. By this function, this unit performs automatic tuning and stores RDS stations with strong signals sequentially. Up to 40 stations are stored automatically in the same way as in the manual preset tuning method on page 29.

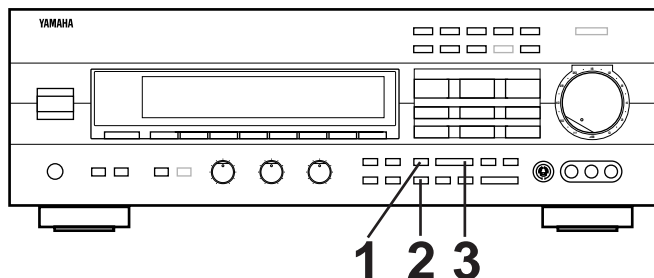
\* Refer to page 32–36 for details on RDS stations.

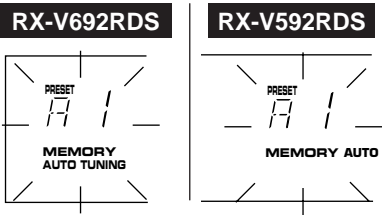
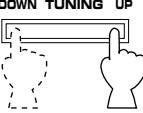

### To store stations

<b>1</b>	 
<b>2</b>	 Press and hold for about 3 seconds.  Flashes.
<b>3</b>	 To tune to higher frequencies, press right side once. To tune to lower frequencies, press left side once. * If the <b>TUNING</b> button is not pressed, in a while, the automatic preset tuning begins automatically toward higher frequencies.  The automatic preset tuning begins from the frequency currently displayed. Received stations are programmed to A1, A2 ... A8 sequentially. * If more than 8 stations are received, they are also programmed to the preset station numbers on other groups (B, C, D and E) in that order.

### When the automatic preset tuning is finished

The display shows the frequency of the last preset station. Check the contents and the number of preset stations by following the procedure of the section "To recall a preset station" on page 29.

### To recall a preset station

Simply follow the procedure of the section "To recall a preset station" on page 29.

\* A recalled station is shown by the frequency or station name on the display.

### Notes

- You can replace a preset station by another FM or AM station manually by simply following the procedure of the section "To store stations" on page 29.
  - The automatic preset tuning search will be performed through all RDS network frequencies until stations are stored up to E8. If the number of received stations is not enough to be stored up to E8, the search is finished automatically after searching all frequencies.
  - With this function, only RDS stations with sufficient signal strength are stored automatically. If the station you want to program is weak in signal strength, tune to it in monaural manually and program it by following the procedure of the section "To store stations" on page 29.
- \* There may be a case that this function cannot receive a station which could be received by the automatic tuning method. This is because this function receives a large volume of PI (Program Identification) data along with the station.

### If you want to store the first station received by the automatic preset tuning to a desired preset station number.

If, for example, you want to store the first received station to C5, select "C5" by using the **A/B/C/D/E** button and the preset station number selector buttons after pressing the **MEMORY** button in step 2. Then press the **TUNING** button. The first received station is stored to C5, and next stations to C6, C7 ... sequentially.

If stations are stored up to E8, the automatic preset tuning is finished automatically.

## EXCHANGING PRESET STATIONS

You can exchange the places of two preset stations with each other as shown below.

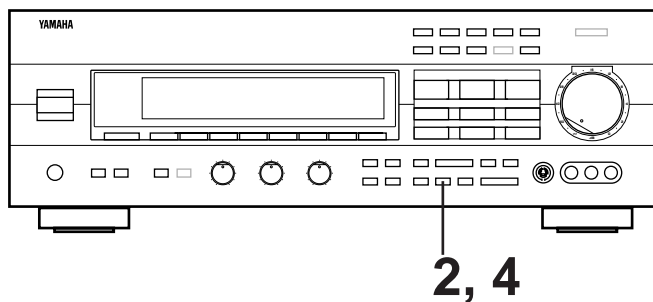

### Example)

If you want to shift the preset station on E1 to A5, and vice versa.

**1** Recall the preset station on E1 (by following the method of "To recall a preset station" on page 29).

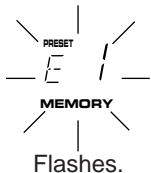
**2**  → 

**3** Next, recall the preset station on A5 by following the same method with step 1.

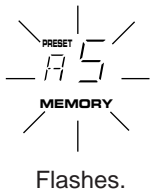

**4** 

↓

**RX-V692RDS** | **RX-V592RDS**

E 1 - - A 5 | E 1 - - - A 5

Shows the exchange of stations is completed.

In areas where RDS broadcasts cannot be received, the RDS broadcast functions do not operate. (The procedures from page 32 to page 36 are not necessary.)

## RECEIVING RDS STATIONS

RDS (Radio Data System) is a data transmission system gradually being introduced by FM stations in many countries. Stations using this system transmit an inaudible stream of data in addition to the normal radio signal.

RDS data contains various information, such as PI (Program Identification), PS (Program Service name), PTY (Program Type), RT (Radio Text), CT (Clock Time), EON (Enhanced Other Networks), etc.

RDS function is carried out among the network stations.

\* This unit utilizes PI, PS, PTY, RT, CT and EON to receive RDS broadcast stations.

### Displaying RDS data

#### RX-V692RDS

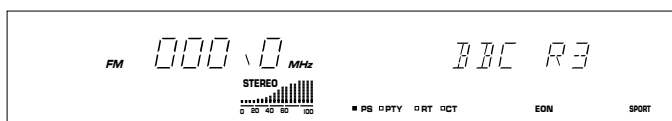

#### RX-V592RDS

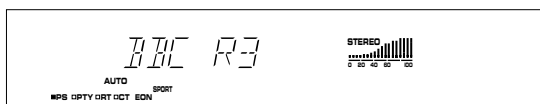

This unit can be turned into the following four modes to display RDS data.

#### PS (Program Service name) mode:

Displays the name of the RDS station now being received instead of the frequency.

#### CT (Clock Time) mode:

Displays current time. This signal comes from the RDS station now being received.

#### PTY (Program Type) mode:

Displays the type of the program on the RDS station now being received. There are 15 program types to classify RDS stations. Refer to the next page for details.

#### EON (Enhanced Other Networks) mode:

Automatically receives a program of the designated program type when its broadcast starts, in place of the program now being received. When the broadcast of the called program ends, the previously received program (or another program on the same station) is recalled.

#### RT (Radio Text) mode:

Displays information about the program (such as title of the song, name of the singer, etc.) on the RDS station now being received.



## Program types in the PTY mode

<b>NEWS</b>	<b>News:</b> Short accounts of facts, events and publicly expressed views, reportage and actuality.	<b>VARIED</b>	<b>Varied:</b> Used for mainly speech-based programs usually of light-entertainment nature, not covered by above categories. Examples are: quizzes, panel games, personality interviews, comedy and satire.
<b>AFFAIRS</b>	<b>Current affairs:</b> Topical program expanding or enlarging upon the news, generally in different presentation style or concept, including documentary debate, or analysis.	<b>POP M</b>	<b>Pop:</b> Commercial music, which would generally be considered to be of current popular appeal, often featuring in current or recent record sales charts.
<b>INFO</b>	<b>Information:</b> Program whose purpose is to impart advice in the widest sense, including meteorological reports and forecasts, consumer affairs, medical help, etc.	<b>ROCK M</b>	<b>Rock:</b> Contemporary modern music, usually written and performed by young musicians.
<b>SPORT</b>	<b>Sport:</b> Program concerned with any aspect of sport.	<b>M.O.R. M</b>	<b>M.O.R.:</b> (Middle of the Road Music). Common term to describe music considered to be "easy-listening", as opposed to Pop, Rock or Classical. Music in this category is often but not always, vocal, and usually of short duration (<5 min.)
<b>EDUCATE</b>	<b>Education:</b> Program intended primarily to educate, of which the formal element is fundamental.	<b>LIGHT M</b>	<b>Light classics:</b> Classical Musical for general, rather than specialist appreciation. Examples of music in this category are instrumental music, and vocal or choral works.
<b>DRAMA</b>	<b>Drama:</b> All radio plays and serials.	<b>CLASSICS</b>	<b>Serious classics:</b> Performances of major orchestral works, symphonies, chamber music etc., and including Grand Opera.
<b>CULTURE</b>	<b>Culture:</b> Programs concerned with any aspect of national or regional culture, including religious affairs, philosophy, social science, language, theatre, etc.	<b>OTHER M</b>	<b>Other music:</b> Musical styles not fitting into any of the above categories. Particularly used for specialist music, of which Jazz, Rhythm & Blues, Folk, Country, and Reggae are examples.
<b>SCIENCE</b>	<b>Science:</b> Programs about the natural sciences and technology.		

## Changing the RDS modes

When an RDS station is received, "PS", "PTY", "RT" and/or "CT" that correspond to the RDS data services employed by the station light up on the display. By pressing the **RDS MODE/FREQ (RDS MODE)** button once or more, you can change the display mode among the RDS modes employed by the received station in the order shown below. (The RDS mode not employed by the station cannot be selected.) Illumination of the indicator on the head of a name of RDS mode shows that the corresponding RDS mode is now selected.

\* When an RDS station is received, do not press the **RDS MODE/FREQ (RDS MODE)** button until one or some names of RDS modes light up on the display. If the button is pressed before one or some names light up on the display, the mode cannot be changed. This is because the unit has not received all of the RDS data on the station yet.

\* If no name of RDS mode lights up on the display, the mode cannot be changed.

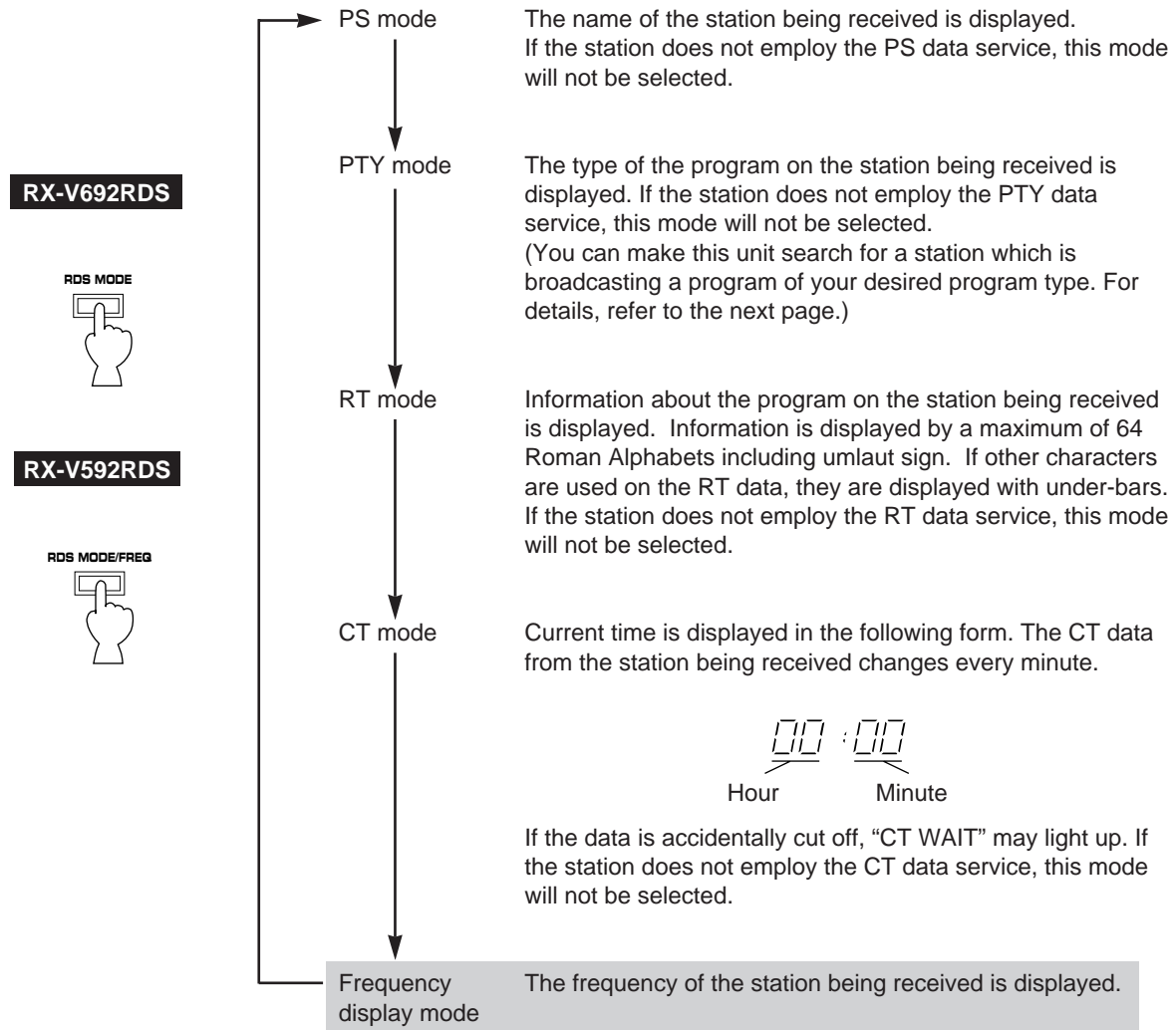

\* The mode in the shaded area is for RX-V592RDS only.

### Notes

- RDS data service cannot be utilized by this unit if the received signal is not strong enough. Especially, the RT (Radio Text mode) needs much data to be received, so it may occur that RT mode cannot be displayed even if other RDS modes (PS, PTY, etc.) are displayed.
- There may be a case that RDS data reception is not possible due to poor reception conditions. If so, press the **TUNING MODE** button so that "AUTO (AUTO TUNING)" goes off from the display. Though the reception mode is changed to monaural by this operation, when you change the display to an RDS mode, RDS data may be displayed.
- If the signal strength gets weakened by external interference during receiving an RDS station, the RDS data service may be cut off suddenly and "...WAIT" will light up on the display.

## Calling a program of your desired program type from among preset RDS stations (PTY SEEK)

By designating a program type, the unit automatically searches all preset stations for an RDS station which broadcasts a program of that program type.

\* There are 15 program types to classify RDS stations. For details, refer to page 33.

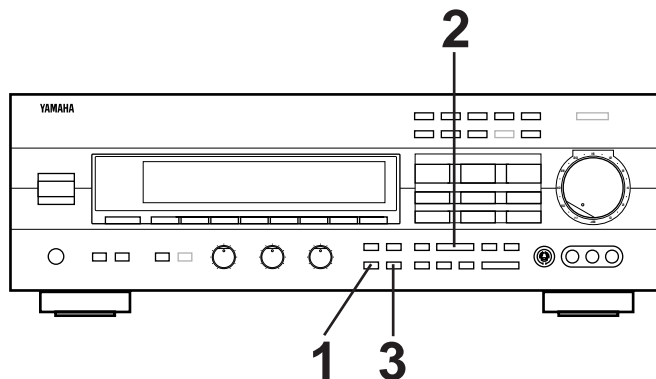

### 1 Turn the unit into the PTY SEEK mode.

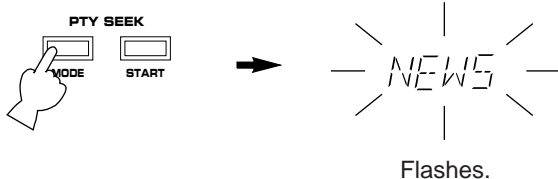

\* The program type of the station now being received or "NEWS" flashes on the display.

### 2 Select the desired program type.

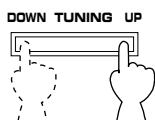

### 3 Begin searching all preset RDS stations.

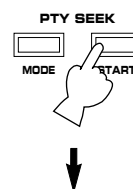

#### RX-V692RDS

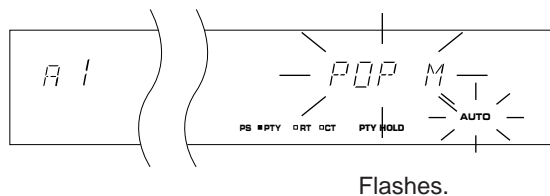

Flashes.

#### RX-V592RDS

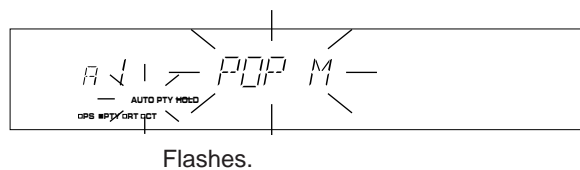

Flashes.

\* "PTY HOLD" lights up on the display.

- If a station which broadcasts a program of the program type is found, the unit stops at the station and displays the frequency of the station.
- If the called station is not the desired one, press the **PTY SEEK START** button once more. The unit begins searching for another station which broadcasts a program of the same program type.
- To stop the search, press the **PTY SEEK START** button once more.

#### To cancel this function

If the **PTY SEEK MODE** button is pressed once more, the PTY SEEK mode is canceled.

## Making this unit call a program of your desired program type automatically when its broadcast starts

This function uses the EON (Enhanced Other Networks) data service on the RDS station network.

By only selecting a desired program type (NEWS, INFO, AFFAIRS or SPORT), this unit automatically searches all preset RDS stations for a station that broadcasts a program of that program type in the background, and, if found, receives a program when its broadcast starts in place of the program now being received.

\* This function can be used only when an RDS station that employs the EON data service is received. (When such a station is received, "EON" lights up on the display.)

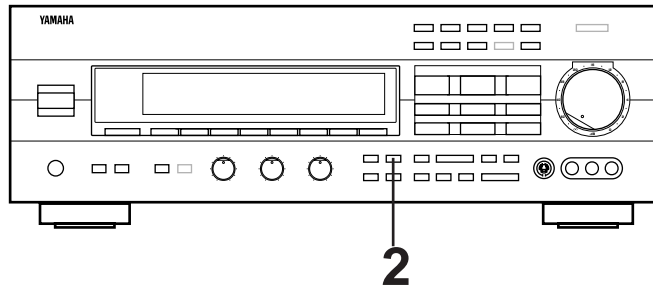

**1** Make sure that "EON" is illuminated on the display.

**RX-V692RDS**

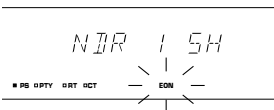

**RX-V592RDS**

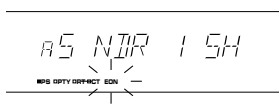

\* If "EON" is not illuminated on the display, receive an (or another) RDS station so that "EON" lights up on the display.

**2** Select a desired program type, NEWS, INFO, AFFAIRS or SPORT.

**RX-V692RDS**

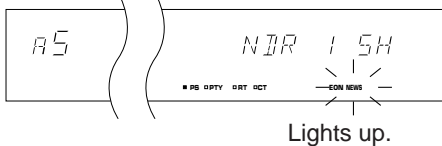

Lights up.

**RX-V592RDS**

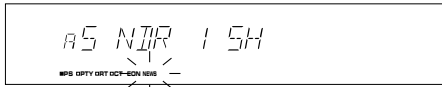

Lights up.

Press once or more.

The search is performed among all preset RDS stations in the background. If a program is found, the program is automatically received when its broadcast starts.

**RX-V692RDS**

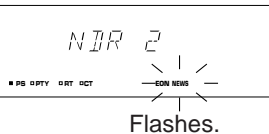

Flashes.

**RX-V592RDS**

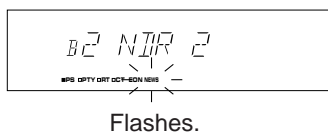

Flashes.

**3** When the broadcast of the called program ends, the previously received program (or another program on the same station) is recalled.

**RX-V692RDS**

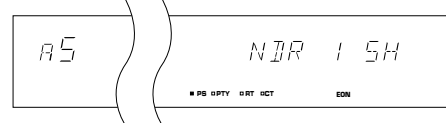

**RX-V592RDS**



### To cancel this function

Press the **EON** button once or more, so that no program type name lights up on the display.

# USING DIGITAL SOUND FIELD PROCESSOR (DSP)

This unit incorporates a sophisticated, multi-program digital sound field processor. The processor allows you to electronically expand and change the shape of the audio sound field from both audio and video sources, creating a theater-like experience in your listening room. You can create an excellent audio sound field by selecting a suitable sound field program (this will, of course, depend on what you will be listening to), and adding desired adjustments.

In addition, this unit incorporates a Dolby Pro Logic Surround decoder for multi-channel sound reproduction of sources encoded with Dolby Surround. The operation of the Dolby Pro Logic Surround decoder can be controlled by selecting a corresponding DSP program including a combined operation of the Yamaha DSP and the Dolby Pro Logic Surround.

## Brief Overview of Digital Sound Field Programs

The following list gives you a brief description of the sound fields produced by each of the DSP programs. Keep in mind that most of these are precise digital recreations of actual acoustic environments. The data for these sound fields was recorded at actual locations using sophisticated sound field measurement equipment.

**Note**  
**The channel level balance between the left and right rear effect speakers may vary depending on the sound field you are listening to. This is due to the fact that most of these sound field recreations are actual acoustic environments.**

PROGRAM	FEATURE
<input checked="" type="checkbox"/> PRO LOGIC	This program is used for playback of sources encoded with Dolby Surround. The application of a sophisticated digital signal processing system reduces crosstalk and directs or steers the sound source more smoothly and precisely, as compared to conventional types.
<input checked="" type="checkbox"/> PRO LOGIC ENHANCED	This program is also used for playback of sources encoded with Dolby Surround. Enhancing the "Normal" Dolby Pro Logic, the DSP technology simulates the multi-surround speaker systems of a 35 mm movie theater. This effect creates a wide surround sound field, and expands the sound stage with an improved presence image. This program is used for musical based movies, as well as drama and comedy based movies.
STADIUM	This program gives you long delays between direct sounds and effect sounds, and extraordinarily spacious feel of a large stadium.
DISCO	This program recreates the acoustic environment of a lively disco in the heart of a very lively city. The sound is dense and highly concentrated. It is also characterized by a high-energy, "immediate" sound.
ROCK CONCERT	This program is ideally suited for rock music. You will experience a very dynamic or lively sound field.
CONCERT HALL	In this program, the center will appear to be deep behind the main speakers, creating an expansive large hall ambience. Orchestra and opera music are suited for this sound field.

**RX-V692RDS only**

<b>PROGRAM</b>	<b>FEATURE</b>
<b>70 mm MOVIE THEATER</b>	This program is effective for playback of sources encoded with Dolby Surround. The Yamaha DSP technology is ideally combined with the Dolby Pro Logic to present you incredible listening experience of the 70 mm film movie theater. This program is ideal for precisely reproducing the sound design of the newest movies. The sound field is made according to the design of the newest movie theaters, so the reverberations of the sound field itself are restrained as much as possible. The three dimensional feeling of the sound field is emphasized, and dialog is precisely oriented on the screen. You can enjoy watching Sci-Fi, adventure movies, etc. with this program.
<b>TV SPORTS</b>	This program is furnished with a tight sound field in which the sound will not spread excessively on the front side, but the rear surround side produces a dynamic sound expansion. This program is the most suitable for sports programs encoded with Dolby Surround.
<b>JAZZ CLUB</b>	This is a small, cozy jazz club with a low ceiling. The sound is very close and intimate.
<b>CHURCH</b>	This program recreates the acoustic environment of a big church with a high pointed dome and columns along the sides. This interior produces very long reverberations.

**RX-V592RDS only**

<b>PROGRAM</b>	<b>FEATURE</b>
<b>CONCERT VIDEO</b>	This program is effective for music videos and gives excellent depth and clarity for vocals. For opera, the orchestra and stage are ideally recreated, letting you feel as if you were in an actual concert hall.
<b>MONO MOVIE</b>	This program is designed specifically to enhance mono source programs. Compared to a strictly mono setting, the sound image created in this mode is wider and slightly forward of the speaker pair, lending an immediacy to the overall sound. It is particularly effective when used with old mono movies, news broadcasts and dialog.

To play a source with the digital sound field processor

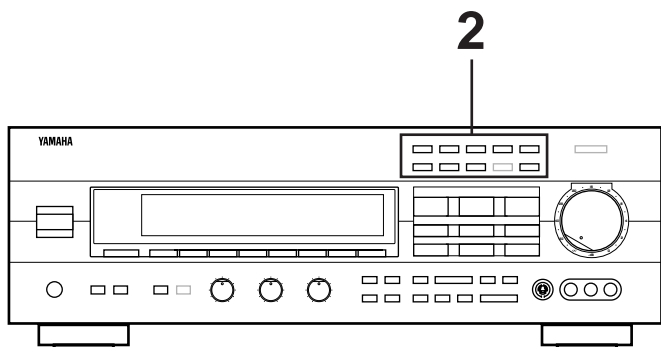

: Provided for RX-V692RDS only.

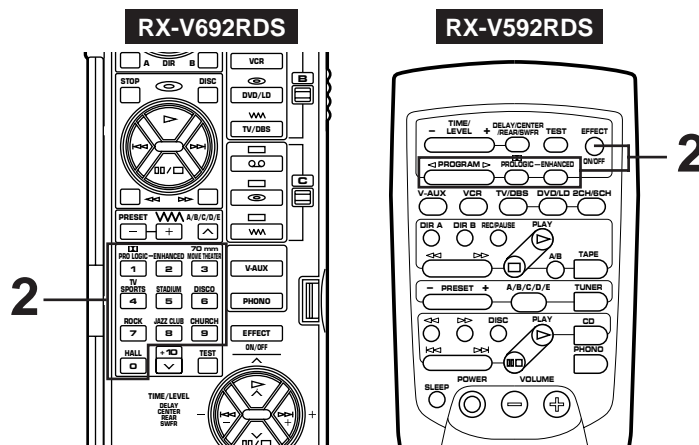

**1** Follow steps 1 – 6 shown in “**BASIC OPERATIONS**” on page 25.

**2** Select the desired program that is suitable for the source.

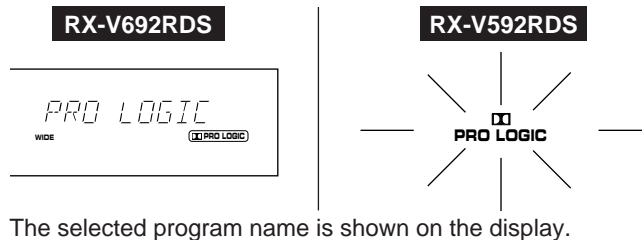
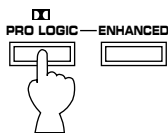

The selected program name is shown on the display.

**3** If desired, adjust the delay time and the output level of each speaker. (For details, refer to the corresponding descriptions on page 40 and 41.)

- When a monaural sound source is played with **DOLBY PRO LOGIC** or **DOLBY PRO LOGIC ENHANCED**, no sound is heard from the main speakers and the rear speakers. Sound is heard only from the center speaker. However, if the center channel mode is in **PHANTOM**, the main speakers output the sound of the center channel.
- When this unit's Dolby Pro Logic Surround decoder is used, if the main-source sound is considerably altered by overadjustment of the **BASS** or **TREBLE** control, the relationship between the center and rear channels may produce an unnatural effect.
- **RX-V592RDS only**

To select a DSP program on the remote control transmitter, first turn the DSP on so that a program name lights up on the display by pressing the **EFFECT** key. Next, select a desired DSP program by pressing the **<** or **>** side of **PROGRAM** key.

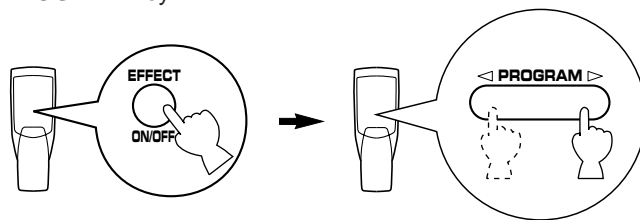

\* Pressing the **PROLOGIC** or **ENHANCED** key turns the DSP on and selects the corresponding program directly.

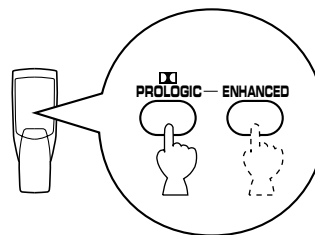

**Notes**

- Program selection can be made to individual input sources. Once you select a program, it is linked with the input source selected at that time. So, when you select the input source next time, the same program is automatically called.
- If you prefer to cancel the DSP, press the **EFFECT** button. The sound will be the normal 2-channel stereo without surround sound effect.
- **RX-V692RDS only**  
When **STADIUM**, **DISCO**, **ROCK CONCERT**, **JAZZ CLUB**, **CHURCH** or **CONCERT HALL** is selected, no sound is heard from the center speaker.
- **RX-V592RDS only**  
When **CONCERT VIDEO**, **MONO MOVIE**, **DISCO**, **STADIUM**, **ROCK CONCERT** or **CONCERT HALL** is selected, no sound is heard from the center speaker.

## Adjustment of the CENTER LEVEL

If desired, you can adjust the sound output level of the center speaker even if the output level is already set in “**SPEAKER BALANCE ADJUSTMENT**” on page 24.

- 1 Press once or more so that “CENTER” appears on the display.

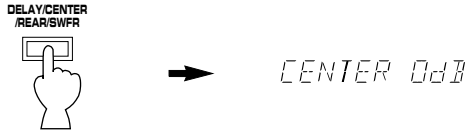

- 2 By continuously pressing the “+” or “-” side of the **TIME/LEVEL** button, the level value changes continuously. The value stops changing momentarily at the preset point (0 dB).

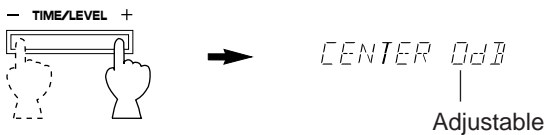

**Control range:** MIN, -20 to +10 dB

### Notes

- **RX-V692RDS only**

This adjustment can be made only when the digital sound field program **DOLBY PRO LOGIC**, **DOLBY PRO LOGIC ENHANCED**, **70 mm MOVIE THEATER** or **TV SPORTS** is selected, or the “6CH” input source mode is selected.

- **RX-V592RDS only**

This adjustment can be made only when the digital sound field program **DOLBY PRO LOGIC** or **DOLBY PRO LOGIC ENHANCED** is selected, or the “6CH” input source mode is selected.

- Once the output level is adjusted, the level value will be the same in all the digital sound field programs mentioned above.

## Adjustment of the REAR LEVEL

If desired, you can adjust the sound output level of the rear speakers even if the output level is already set in “**SPEAKER BALANCE ADJUSTMENT**” on page 24.

- 1 Press once or more so that “REAR” appears on the display.

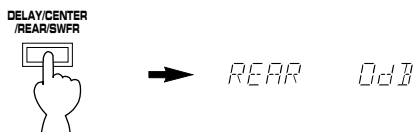

- 2 By continuously pressing the “+” or “-” side of the **TIME/LEVEL** button, the level value changes continuously. The value stops changing momentarily at the preset point (0 dB).

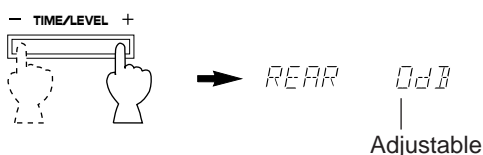

**Control range:** MIN, -20 to +10 dB

### Notes

- This adjustment can be made only when the built-in digital sound field processor is on, or the “6CH” input source mode is selected.
- Once the output level is adjusted, the level value will be the same in all the digital sound field programs.



## Adjustment of DELAY TIME

You can adjust the time difference between the beginning of the sound from the main speakers and the beginning of the effect sound from the rear speakers.

The larger the value, the later the effect sound is generated. This adjustment can be made to all programs individually.

### RX-V692RDS

<b>PRO LOGIC</b>	: from 15 to 30 milliseconds (Preset value: 20 milliseconds)
<b>PRO LOGIC ENHANCED</b>	: from 15 to 30 milliseconds (Preset value: 20 milliseconds)
<b>70 mm MOVIE</b>	: from 15 to 30 milliseconds (Preset value: 17 milliseconds)
<b>THEATER</b>	: from 1 to 50 milliseconds (Preset value: 20 milliseconds)
<b>TV SPORTS</b>	: from 1 to 50 milliseconds (Preset value: 45 milliseconds)
<b>STADIUM</b>	: from 1 to 50 milliseconds (Preset value: 14 milliseconds)
<b>DISCO</b>	: from 1 to 50 milliseconds (Preset value: 26 milliseconds)
<b>ROCK CONCERT</b>	: from 1 to 50 milliseconds (Preset value: 40 milliseconds)
<b>JAZZ CLUB</b>	: from 1 to 50 milliseconds (Preset value: 30 milliseconds)
<b>CHURCH</b>	: from 1 to 50 milliseconds (Preset value: 30 milliseconds)
<b>CONCERT HALL</b>	: from 1 to 50 milliseconds (Preset value: 30 milliseconds)

### RX-V592RDS

<b>PRO LOGIC</b>	: from 15 to 30 milliseconds (Preset value: 20 milliseconds)
<b>PRO LOGIC ENHANCED</b>	: from 15 to 30 milliseconds (Preset value: 20 milliseconds)
<b>CONCERT VIDEO</b>	: from 1 to 100 milliseconds (Preset value: 28 milliseconds)
<b>MONO MOVIE</b>	: from 1 to 100 milliseconds (Preset value: 20 milliseconds)
<b>STADIUM</b>	: from 1 to 50 milliseconds (Preset value: 45 milliseconds)
<b>DISCO</b>	: from 1 to 100 milliseconds (Preset value: 14 milliseconds)
<b>ROCK CONCERT</b>	: from 1 to 100 milliseconds (Preset value: 17 milliseconds)
<b>CONCERT HALL</b>	: from 1 to 100 milliseconds (Preset value: 30 milliseconds)

- 1 Press once or more so that "DELAY" appears on the display.

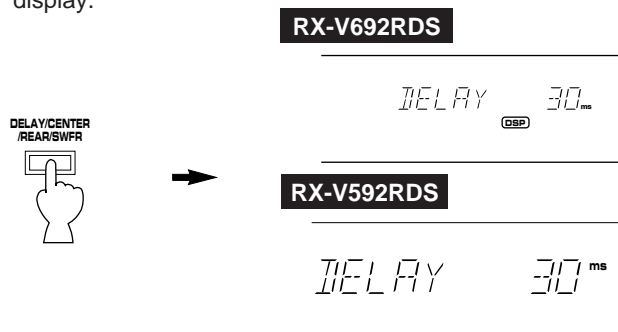

- 2 By continuously pressing the "+" or "-" side of the **TIME/LEVEL** button, the value changes continuously. The value stops changing momentarily at the preset point.

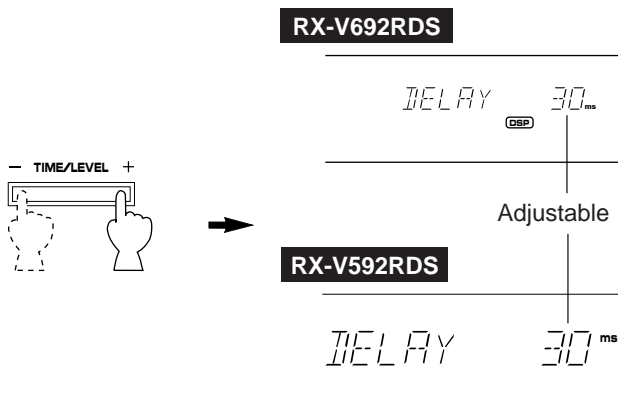

### Notes

- Adding too much delay will cause an unnatural effect with some sources.
- When the **TIME/LEVEL** button is pressed, sound is momentarily interrupted.

### Note

The values of the delay time, center level and rear level you set the last time will remain memorized even when the power of this unit is off.

However, if the power cord is kept disconnected for more than one week, these values will be automatically changed back to the original factory settings.

# SETTING THE SLEEP TIMER

If you use the SLEEP timer of this unit, you can make this unit turn off automatically. When you are going to sleep while enjoying a broadcast or other desired input source, this timer function is helpful.

## Notes

- The SLEEP timer can be controlled only with the remote control transmitter.
- The components on which the SLEEP timer is effective are the sources connected to the **SWITCHED AC OUTLET(S)** on the rear panel of this unit.

## To set the SLEEP time

**1**

**RX-V692RDS**

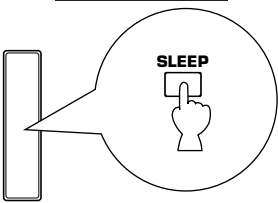

**RX-V592RDS**

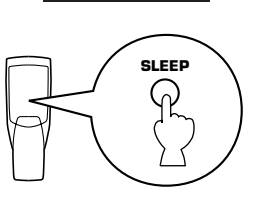

Press once or more to select the desired SLEEP time.

↓

**RX-V692RDS**

Indicates the SLEEP time.

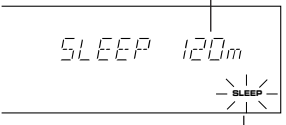

Lights up.

**RX-V592RDS**

Indicates the SLEEP time.



Lights up.

Whenever the **SLEEP** key is pressed, the SLEEP time will change as follows.

(Minutes)

120 → 90 → 60 → 30

The SLEEP timer is off (OFF).  
(The state before the **SLEEP** key is pressed.)

After a while, the display returns to the indication before the SLEEP timer is set.

**2** The unit will be turned off automatically at the selected SLEEP time.

## To cancel the selected SLEEP time

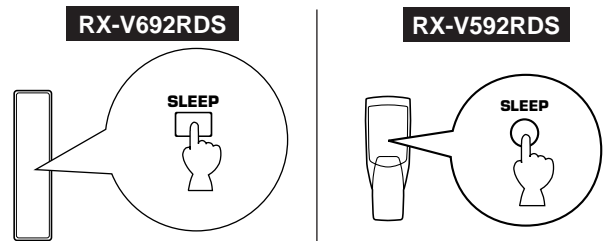

Press once or more so that "SLEEP OFF" appears on the display. (It will soon disappear and the "SLEEP" indicator will go off from the display.)

## Note

The SLEEP timer setting can also be canceled by turning off the power with the **POWER** switch or disconnecting the power plug of this unit from the AC outlet.

# REMOTE CONTROL TRANSMITTER

## for RX-V692RDS only

### BASIC OPERATIONS (When the lid is open)

The remote control transmitter provided with this unit is designed to control all the most commonly used functions of this unit. If the CD player, tape deck, LD player etc. connected to this unit are YAMAHA components designed for remote control compatibility, then this remote control transmitter will also control various functions of each component.

\* For basic operations, use the remote control transmitter with the lid open.

### NAMES OF KEYS AND THEIR FUNCTIONS

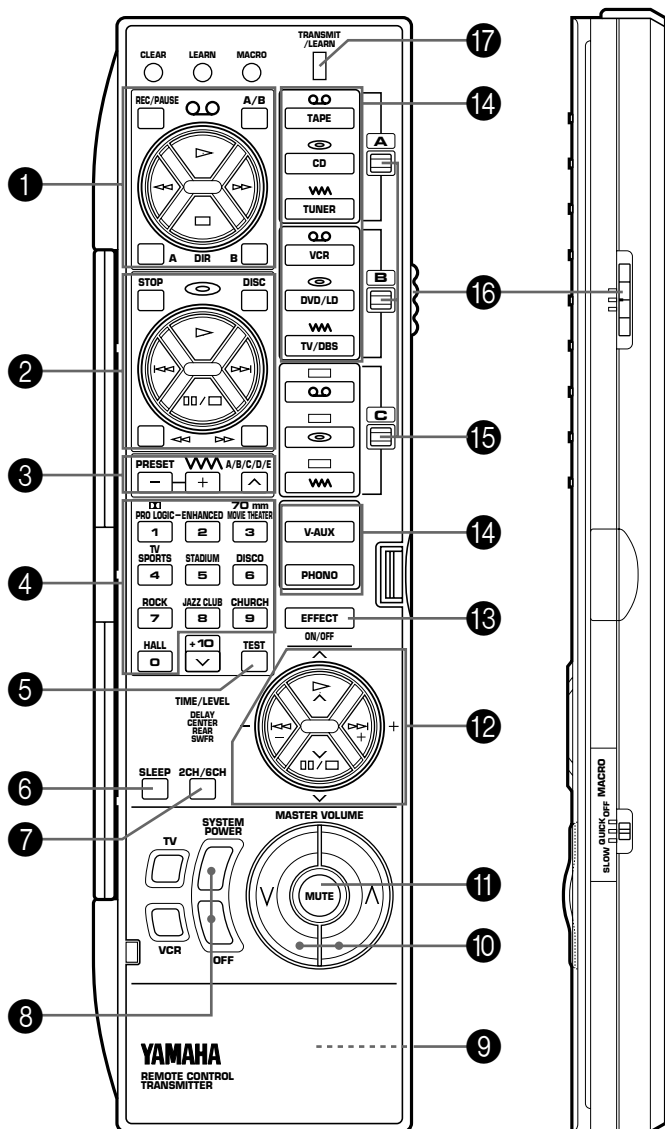

Lid is opened.

Side panel

### 1 Tape deck keys

Controls tape deck.

(The A/B/C switch (16) should be set to the "A" position.)

- \* **DIR A, B** and **A/B** are applicable only to double cassette tape deck.
- \* For a single cassette deck with automatic reverse function, pressing **DIR A** will reverse the direction of tape running.

### 2 CD/LD player keys

Controls compact disc player or LD player.

(To control compact disc player, set the A/B/C switch (16) to the "A" position. To control LD player, set the A/B/C switch (16) to the "C" position.)

- \* **DISC** is applicable only to compact disc changer.
- \* **STOP** is applicable only to LD player.

### 3 Tuner keys

Controls tuner.

(The A/B/C switch (16) should be set to the "A" position.)

- +**: Selects higher preset station number.
- : Selects lower preset station number.
- A/B/C/D/E**: Selects the group (A – E) of preset station numbers.

### 4 DSP program selector keys

Selects a DSP program when the built-in digital sound field processor (including the Dolby Pro Logic Surround decoder) is on.

### 5 TEST key

Used for speaker balance adjustment. (For details, refer to page 22–24.)

### 6 SLEEP timer key

This key is used to turn the built-in SLEEP timer on and off, and to set the SLEEP time. (See page 42 for details.)

### 7 2CH/6CH selector key

When the **TV/DBS** or **DVD/LD** input source is selected, pressing this key switches the input signals between 2 channel stereo signals and 6 channel discrete signals. When switched to "6CH", discrete signals from the unit connected to the 6CH DISCRETE INPUT DVD/LD TV/DBS terminals of this unit are selected as the input signals.

### 8 SYSTEM POWER and OFF keys

Pressing the **SYSTEM POWER** key turns the power of this unit on and pressing the **OFF** key turns the power off.

- \* While the power is on, pressing these keys switches the unit from the power-on mode to the standby mode, and vice versa. (In the standby mode, the standby mode indicator on the front panel is illuminated.)

### 9 RESET button

This button is inside the battery compartment.

Press this button to "reset" the internal microcomputer which controls remote control operations. Microcomputer "reset" is necessary when the remote control freezes.

- \* Pressing the **RESET** button will not erase learned functions.

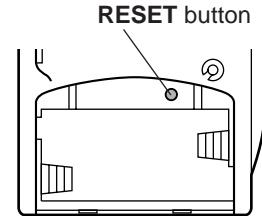

### 10 MASTER VOLUME ^ (up) and v (down) keys

Turns the volume level up and down.

### 11 MUTE key

When pressed, this key mutes the volume level. To resume the original volume level, press this key again.

While muting, the indicator on the **VOLUME** control flashes continuously.

### 12 DELAY/CENTER/REAR/SWFR selector (^ / v) and TIME/LEVEL +/- keys

Adjust the delay time (DELAY), the center channel output level (CENTER), the rear channel output level (REAR) and the output level to the SUBWOOFER OUTPUT terminal (SWFR). Select the item which you want to adjust by pressing the ^ or v key and adjust its time or level by pressing the + or – key.

### 13 EFFECT ON/OFF key

Switches on/off the digital sound field processor (including the Dolby Pro Logic Surround decoder).

### 14 Input selector keys

Selects input source.

### 15 A/B/C indicators

The position (A, B or C) selected by the A/B/C switch is shown in red.

### 16 A/B/C switch

This switch must be used only when the lid of the remote control transmitter is open. (This switch will not function when the lid is closed.)

Normally, set this switch to the "A" position. When controlling a Yamaha LD player by using the CD/LD player keys (2), set this switch to the "C" position.

### 17 TRANSMIT/LEARN indicator

Lights up when the remote control transmitter is transmitting infrared signals (when a command key is pressed).

#### Note

When using the keys to control Yamaha components, identify them with your component's keys. If these keys are identical, their functions will be the same. For each key function, refer to the corresponding instruction in your component's manual.

## LEARNING NEW CONTROL FUNCTIONS (When the lid is open)

This is a learning remote control transmitter. The shaded keys in the illustration shown below can be programmed to “learn” control functions from other remote control transmitters. By learning key-functions from other remote control transmitter, this unit can then be used in place of one or more other remote control transmitters, thus making operation of your various audio and video components more convenient.

Some of the “learning-capable” keys are originally empty and others have already been preset with functions to control this unit and other Yamaha components. You can store new functions to them (in place of preset functions) as desired.

\* See page 50 for the learning method.

\* See page 52 for clearing a learned function (or all learned functions).

### Note

If the memory capacity of the remote control transmitter becomes full, no further learning is possible even if some learning-capable keys are not occupied with new functions. If, for example, you store Yamaha codes only into this remote control transmitter, up to about 20 functions can be stored. Store new functions to the learnable-capable keys which are useful for you.

### Keys which can have three functions (①, ②, ③, ④)

In the “Learning-capable” keys, the keys numbered ①–④ in the illustration at left can have three functions. This is because they have three memory areas (A, B and C). (One function per area.) You can store new functions into the area B and C, and use three functions on a key by switching the memory areas with the **A/B/C switch**. (Area A cannot learn a new function.)

### To use these keys:

1. Before using a key, select the area A, B or C of the key on which the function you want to use is stored by using the **A/B/C switch**.
2. Press the key.

The original factory settings of these keys are as follows.

	The position of A/B/C switch		
	A	B	C
①	Preset with functions for controlling a Yamaha tape deck.	Empty	Empty
②	Preset with functions for controlling a Yamaha CD player. ( <b>STOP</b> is empty.)	Empty	Preset with functions for controlling a Yamaha LD player. ( <b>DISC</b> is empty.)
③	Preset with functions for controlling the built-in tuner.	Empty	Empty
④	Preset as the DSP program selector keys (1–9, 0) and the <b>TEST</b> key. ( <b>+10</b> is empty.)	Preset as the DSP program selector keys (1–9, 0) and the <b>TEST</b> key. ( <b>+10</b> is empty.)	Preset as the DSP program selector keys (1–9, 0) and the <b>TEST</b> key. ( <b>+10</b> is empty.)

### Note

The area A of all keys cannot learn new functions. To store new functions to these keys, store them onto the area B or C.

### Empty keys (①, ②)

These are empty keys. Each key can learn a function from another remote control transmitter.

For example, the **TV** key is useful for storing the function of your TV's power switch, and the **VCR** key can be used for your VCR's power switch.

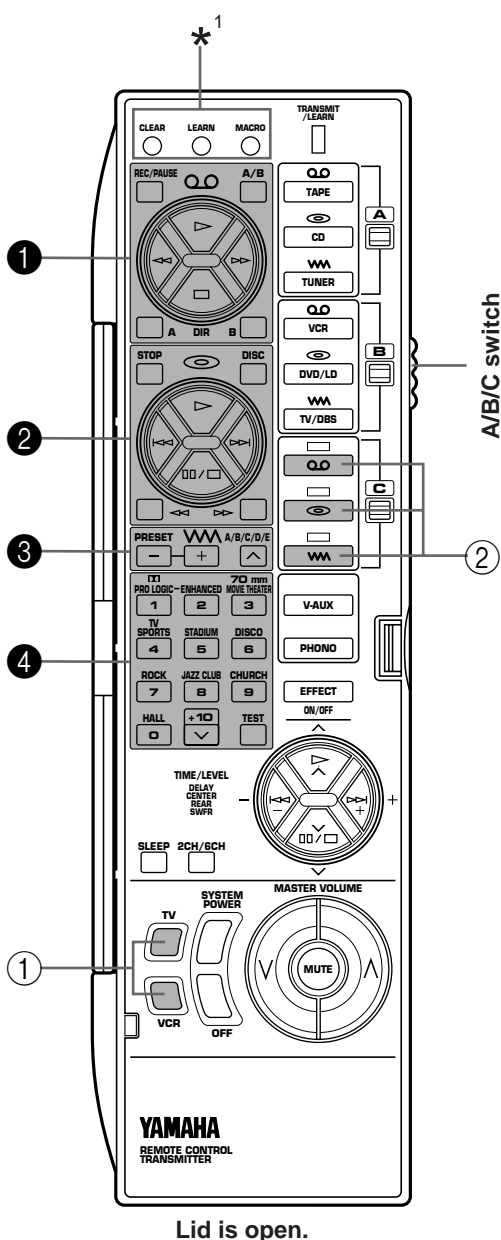

\*<sup>1</sup>: These buttons are used for learning a new function or clearing a learned function (or all learned functions). See page 50–52 for details.

**Note**

If a key which has a preset function learns a new function, the preset function will not be deleted, but disabled. When the learned function is cleared, the preset function is restored. (For information on clearing a learned function, refer to page 52.)

**About the marks shown on the remote control transmitter**

The marks on the remote control transmitter signify functions of keys, input sources, etc.

**Examples)**

- ◻◻ (tape): Shows tape deck, VCR, etc.
- ◻◻ (disc): Shows CD player, LD player, etc.
- ◻◻ (radio wave): Shows tuner, TV/BS tuner, etc.

These marks are helpful for storing new functions.

**Examples)**

- The area B of keys ① is suitable for storing functions to control your VCR.
- The area B of keys ③ is suitable for storing functions to control your TV/BS tuner.

**USING OPERATION CONTROL KEYS (When the lid is closed)**

When the lid of the remote control transmitter is closed, you can easily operate Yamaha components including learned functions by using the **OPERATION CONTROL** keys.

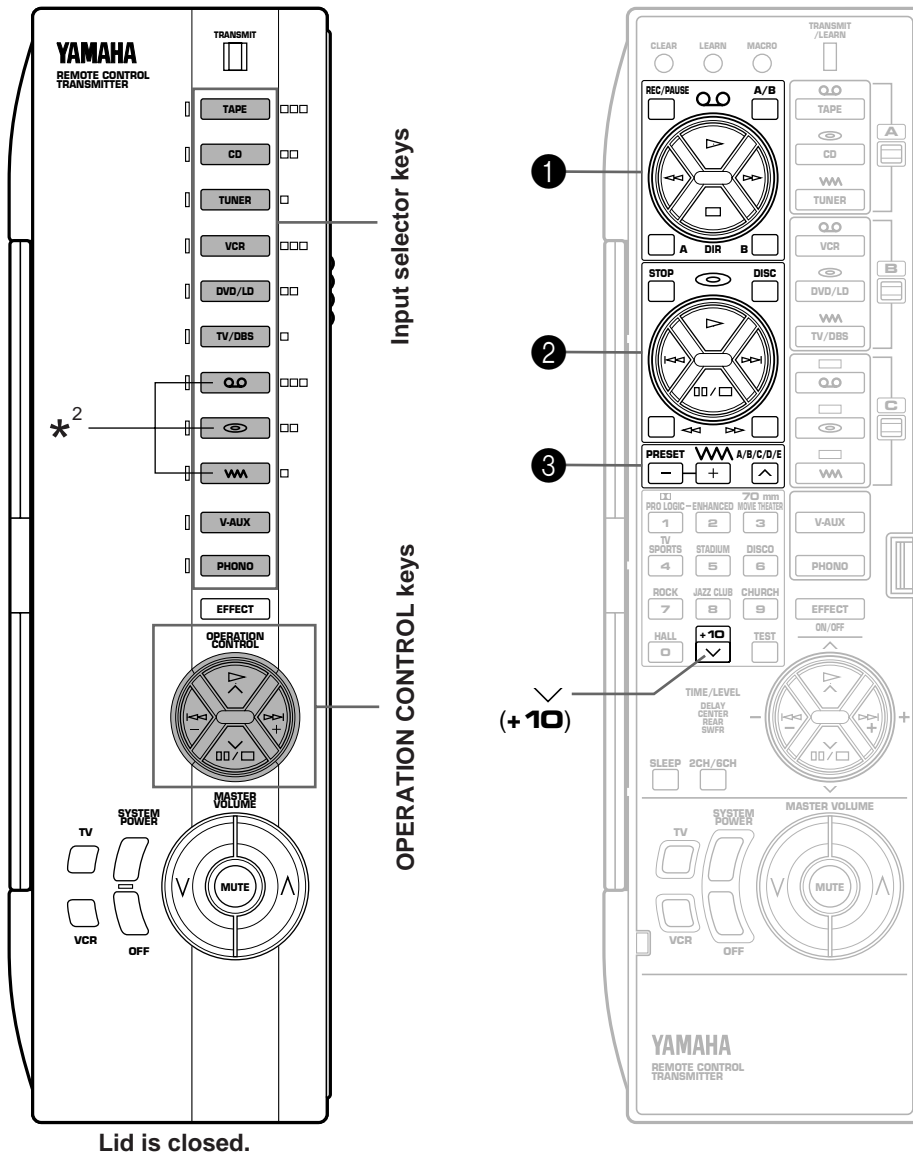

\*<sup>2</sup>: These keys are originally empty. If these keys have learned functions, pressing them executes those learned functions.

When the lid is closed, the **OPERATION CONTROL** keys substitute for the keys numbered ①, ②, ③ and the √ (+10) key on the left illustration. To use these keys, you do not have to switch the A/B/C switch. The functions which the **OPERATION CONTROL** keys carry out are determined by which input selector key was pressed before you used the **OPERATION CONTROL** keys.

#### Note

When the lid is closed, the **EFFECT, MASTER VOLUME, MUTE, TV** and **VCR** keys will function in the same way as when the lid is open.

\* If the **MACRO** switch on the side of the remote control transmitter is set to "OFF", when the lid is closed, the **SYSTEM POWER** and **OFF** keys also will function in the same way as when the lid is open.

#### Examples of operations controlled by using the OPERATION CONTROL keys

##### To operate a Yamaha CD player

1. Press the "CD" input selector key.
2. Use the **OPERATION CONTROL** keys. (They carry out the functions in area A of keys ②.)

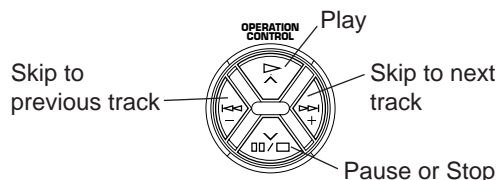

##### To operate your VCR

1. Press the "VCR" input selector key.
2. Use the **OPERATION CONTROL** keys. (They carry out the functions in area B of keys ①. This area is originally preset with no function. You must store the functions related to controlling the VCR in area B of keys ① beforehand.)

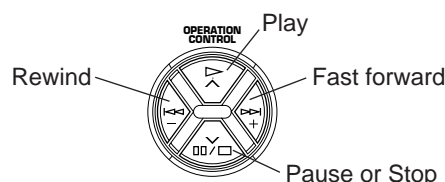

See the table below for a combination of an input selector key and key functions which the **OPERATION CONTROL** keys carry out. (Also, refer to the table on page 45.)

Selected input selector	Key functions which the OPERATION CONTROL keys carry out
TAPE	Functions in area A of keys ① (except REC/PAUSE, A/B, DIR A and B)
CD	Functions in area A of keys ② (except STOP, DISC, <<< and >>> )
TUNER	Functions in area A of keys ③ and √ (+10)
VCR	Functions in area B of keys ① (except REC/PAUSE, A/B, DIR A and B)
DVD/LD	Functions in area B of keys ② (except STOP, DISC, <<< and >>> )
TV/DBS	Functions in area B of keys ③ and √ (+10)
QD	Functions in area C of keys ① (except REC/PAUSE, A/B, DIR A and B)
⊖	Functions in area C of keys ② (except STOP, DISC, <<< and >>> )
WA	Functions in area C of keys ③ and √ (+10)

Pressing the "V-AUX" or "PHONO" input selector key has no effect on the **OPERATION CONTROL** keys.

#### Notes

- If the **OPERATION CONTROL** keys substitute for keys which has no function (empty), no command is carried out. According to your plan, store functions from other remote control transmitters into an empty area of those keys. (Refer to page 50 for the learning method.)
- While playing an audio/video unit, if you want to operate another unit by using the remote control transmitter (for example, if you want to rewind a tape on your VCR while listening to a CD), you should open the lid of the remote control transmitter and use the A/B/C switch and the corresponding keys. (If you press an input selector key with the lid closed to change the functions of the **OPERATION CONTROL** keys to the functions for controlling a VCR, the input of currently playing CD source is canceled.)

## MACRO OPERATIONS (When the lid is closed)

“Macro” is a command which defines a sequence of several operations.

The keys shown in the illustrations below (as **preset macro keys**) are also preset with macros, in addition to individual functions.

Each macro key is preset so that simply pressing it alone will carry out several functions of other keys on this remote control transmitter sequentially. (To know what key functions are sequentially carried out by pressing each preset macro key, see the next page.)

Macros can be used only when the lid is closed and the **MACRO** switch is set to “SLOW” or “QUICK”. (If “OFF” is selected, no macro will function even if the lid is closed.)

Preset macro keys are originally preset with macros. If you prefer, however, you can change the contents of a macro key by storing a desired series of functions on it. You can store up to seven functions onto a macro key. (See page 51 for the learning method.)

### Setting the MACRO switch

**OFF:** In this position, no macro will function even if the lid of remote control transmitter is closed.

**QUICK:** In this position, when a macro key is pressed, each command is transmitted at 0.5 second intervals.



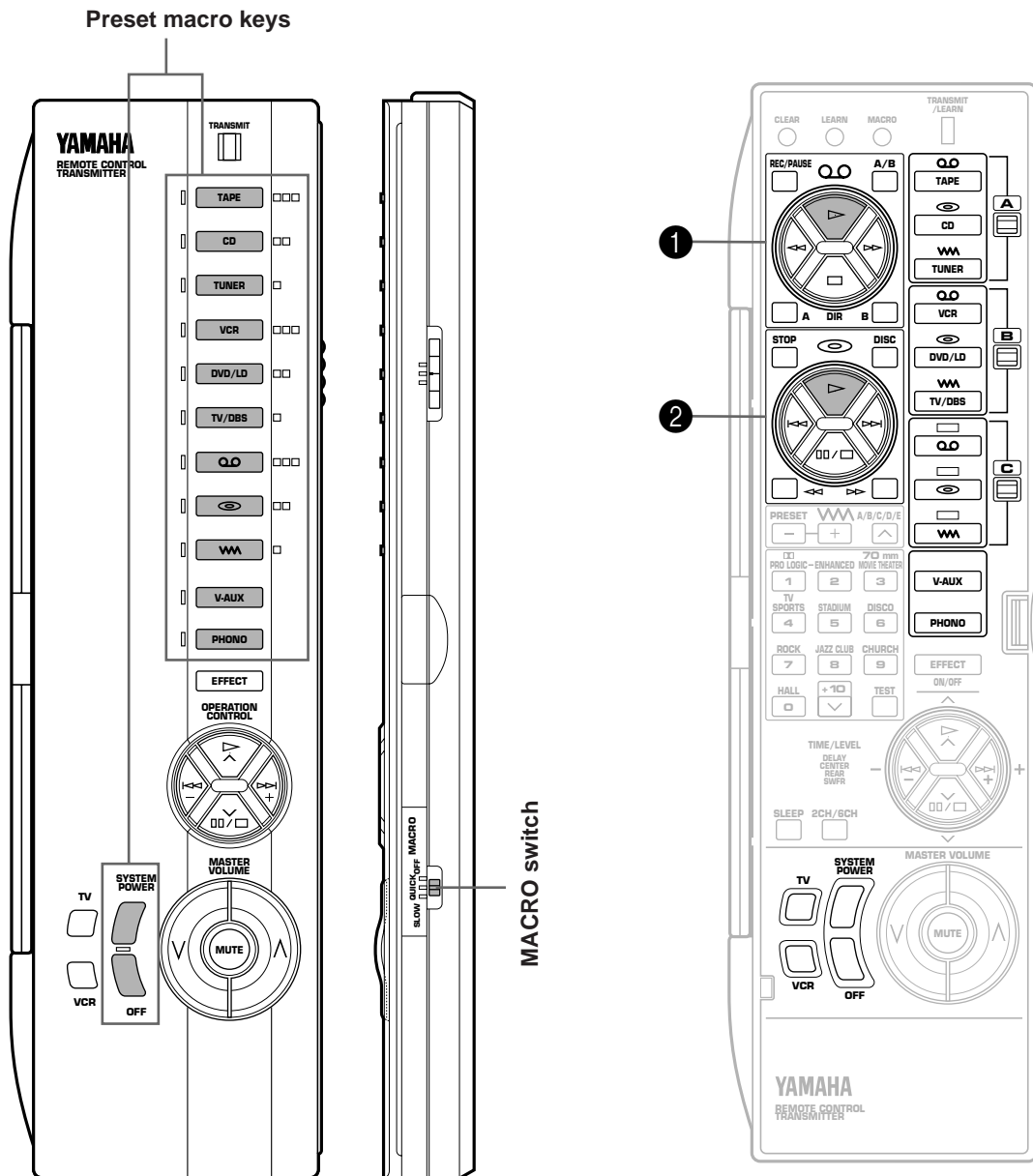





















**SLOW:** In this position, when a macro key is pressed, each command is transmitted at 3 second intervals.









Lid is closed.  
(Set the MACRO switch to “QUICK” or “SLOW”.)



Preset macro keys and the key functions which they carry out sequentially are as follows. (Also, refer to the table on page 45.)

Macro key	Function of the key (and area) which operates when a macro key is pressed		
	1st (Turning the power of this unit on)	2nd (Selecting an input source)	3rd (Playing a source)
 TAPE	SYSTEM POWER 	 TAPE	“▷” on area A of keys ①
 CD		 CD	“▷” on area A of keys ②
 TUNER		 TUNER	—
 VCR		 VCR	“▷” on area B of keys ①
 DVD/LD		 DVD/LD	“▷” on area B of keys ②
 TV/DBS		 TV/DBS	—
 Q.D		 Q.D	“▷” on area C of keys ①
 		 	“▷” on area C of keys ②
 WMA		 WMA	—
 V-AUX		 V-AUX	—
 PHONO		 PHONO	—

Macro key	Function of the key which operates when a macro key is pressed		
	1st	2nd	3rd
SYSTEM POWER 	SYSTEM POWER 	TV 	 VCR
 OFF	 OFF	—	—

### Notes

- A key in which no function is stored will carry out no command.
- If it occurs that this unit will not receive the second command because the internal operation of the first command takes a long time, set the **MACRO** switch to the “SLOW” position, or add no function or repeat the same command between the first command and the next command.
- If you will program the power on/off switching function of TV, VCR, etc. as part of a macro sequence, note that it switches the current mode to the other (“on” to “off”, or “off” to “on”). For example, when you press the macro key, if the power of TV, VCR, etc. is already on, the power will be turned off even though you may not want it to do so.
- Once you press a macro key, this unit will not receive the command of another key (even if it is pressed) until this unit finishes carrying out all commands of the macro key. Take notice of this especially when the **MACRO** switch is in the “SLOW” position.
- Once you press a macro key, you must keep the remote control transmitter directed at the main unit’s remote control sensor until the remote control transmitter finishes transmitting all command signals of the macro key.
- You can use the **OPERATION CONTROL** keys also while using the macro functions.

# LEARNING A NEW FUNCTION

- 1** Place this remote control transmitter and the other remote control transmitter so that they face each other.

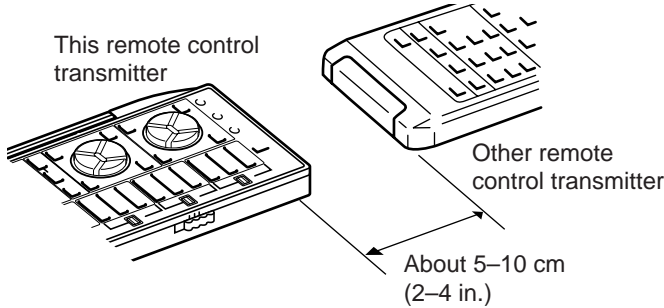

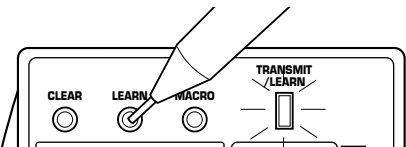
- 2**  (Press by using the point of a mechanical pencil, etc.) **Flashes slowly.**

- \* If there is no operation for about 30 seconds after the **LEARN** button is pressed, the TRANSMIT/LEARN indicator flashes rapidly and the current mode is canceled. If this occurs, repeat this step.

- 3** If necessary, select the memory area by using the A/B/C switch on the side panel of the remote control transmitter.

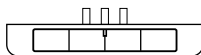

- 4** Press the key on this remote control transmitter in which you will store a new function.

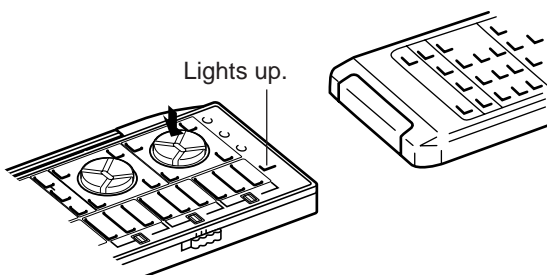

- \* If a key which cannot learn another function is pressed, the TRANSMIT/LEARN indicator flashes rapidly and the current mode is canceled. If this occurs, repeat this step.  
\* If there is no operation for about 30 seconds after a key is pressed, the TRANSMIT/LEARN indicator flashes rapidly and the mode before you began learning operations is restored. If this occurs, restart from step 2.

- 5** Press and hold the key (on the other remote control transmitter) which has the function you want to store.

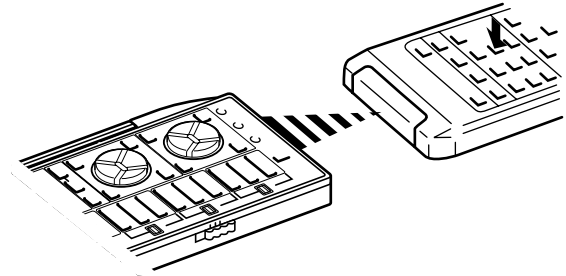

- \* When learning is finished, the TRANSMIT/LEARN indicator stops lighting and then begins flashing slowly.  
\* If a signal is not successfully received, the TRANSMIT/LEARN indicator flashes rapidly and the mode prior to step 4 is restored. If this occurs, restart from step 4.  
\* If memory capacity is full, the TRANSMIT/LEARN indicator flashes rapidly to show you that learning is impossible, and then the mode before you began learning operations is restored.

- 6** Repeat step 3-5 to store more functions.

- 7** When you finish the learning operation, press the **LEARN** button.

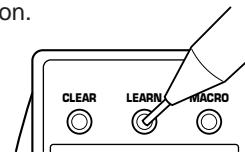

## Notes

- Newly learned functions will replace previously learned functions.
- If there is no more room in the memory area for a function to be learned, the TRANSMIT/LEARN indicator will flash rapidly. In this case, even if some keys are not occupied with functions from other remote control transmitters, no further learning is possible.
- If the lid is closed while learning and about 5 seconds pass, the TRANSMIT/LEARN indicator flashes rapidly and the mode before you began learning operations is restored. If this occurs, restart from step 2. However, if the lid is opened within 5 seconds, the mode before the lid was closed is restored.
- There may occasionally be instances in which, due to the signal-coding and modulation employed by the other remote control transmitter, this remote control transmitter will not be able to "learn" its signals.

## MAKING A NEW MACRO

A new macro can be programmed onto any preset macro key in place of preset functions. (See page 48 to know what keys are preset macro keys.) You can make as many as 13 new macro keys. A macro key can learn as many as seven functions of other keys.

### Note

If you store a continuous command such as lowering of volume level, it will become a short command when it is carried out as a part of macro.

# 1

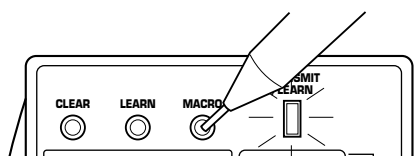

Flashes slowly.

- \* If there is no operation for about 30 seconds after the **MACRO** button is pressed, the **TRANSMIT/LEARN** indicator flashes rapidly and the mode before you pressed the **MACRO** button is restored. If this occurs, press the **MACRO** button again.

# 2

Press a preset macro key on which you want to make a new macro.



Lights up.

- \* If a key other than a preset macro key is pressed, the **TRANSMIT/LEARN** indicator flashes rapidly and the current mode is canceled. If this occurs, repeat this step.

# 3

Press a key whose function you want to store as the first function of the new macro.

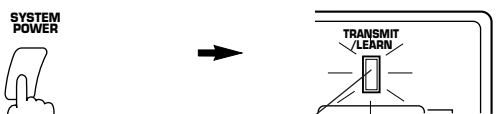

Goes off.  
(When learning is finished, this indicator lights up again.)

- \* If a key whose function cannot be stored as a command of macro is pressed, the **TRANSMIT/LEARN** indicator flashes rapidly and the current mode is canceled. If this occurs, repeat this step.
- \* If about 30 seconds pass before a key is pressed, the **TRANSMIT/LEARN** indicator flashes rapidly and the mode before you began learning operations is restored. If this occurs, restart from step 1.

# 4

Repeat step 3 to store the second, the third and more functions. You can store up to seven key functions in series as a macro.

- \* If the seventh key function has been learned, the **TRANSMIT/LEARN** indicator flashes rapidly and the mode before you began learning operations is restored. (This shows that the key has completed learning a series of functions as a macro.) If this occurs, you do not have to follow the next step.

# 5

When you finish learning, press the **MACRO** button.

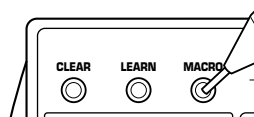

It is recommended to write down new key functions you stored on the provided user function stickers and paste them on the reverse side of the remote control transmitter or the reverse side of the remote control transmitter's lid.

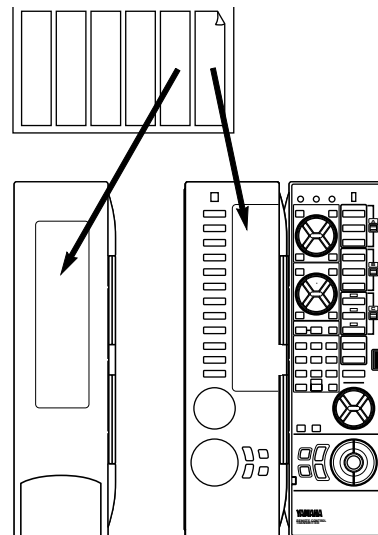

### Memory back-up

All of the learned functions will be retained while you replace the batteries. However, if no batteries are installed for a few hours, the learned functions will be erased and will have to be learned again.

# CLEARING LEARNED FUNCTIONS

## To Clear a Learned Function

- 1 To clear a learned key function, press the **LEARN** button using the point of a mechanical pencil, etc. To clear a macro you made, press the **MACRO** button.

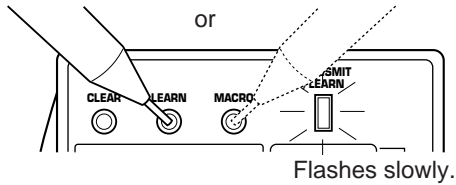

- 2 Press and hold the **CLEAR** button using the point of a mechanical pencil, etc.

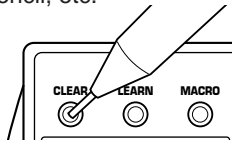

- 3 Holding the **CLEAR** button pressed, press and hold the key whose function you want to clear until the indicator flashes 3 times.

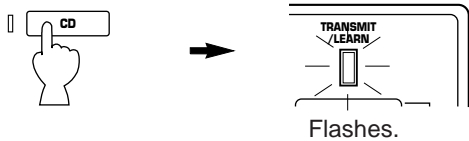

To clear two or more functions sequentially, do not release the **CLEAR** button pressed, and repeat this step.

### Note

If you clear a learned function of a key, the originally preset function of the key is restored (except the keys which are originally preset with no function.)

## Trouble shooting guide

SYMPTOM	CAUSE	REMEDY
The remote control transmitter does not work.	The batteries of this remote control transmitter are weak. The internal microcomputer "freezes".	Replace the batteries with new ones and press the RESET button on the remote control transmitter.
Learning cannot be made successfully. (The TRANSMIT/LEARN indicator does not light up or flash.)	The batteries of this remote control transmitter and/or the other remote control transmitter are weak.	Replace the batteries (and press the RESET button for this remote control transmitter).
	The distance between the two remote control transmitters is too long or too short.	Place the remote control transmitters with the proper distance.
	The signal coding or modulation of the other remote control transmitter is not compatible with this remote control transmitter.	Learning is not possible.
	Memory capacity is full.	Further learning is not possible without deleting unnecessary commands.
	The internal microcomputer "freezes".	Press the RESET button on the remote control transmitter.

## To Clear All Learned Functions

- 1 Select the kind of key functions all of which you want to clear by using the **MACRO** switch on the side panel of the remote control transmitter.

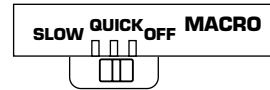

- OFF:** Select this position if you want to clear all of the learned functions except macros.
- QUICK:** Select this position if you want to clear all of the macros you made only.
- SLOW:** Select this position if you want to clear all of the learned functions including macros.

- 2 Press the **CLEAR** button using the point of a mechanical pencil, etc.

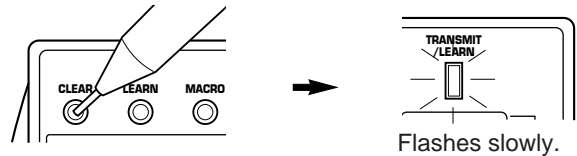

- \* If one of the following operation is made after you press the **CLEAR** button, the TRANSMIT/LEARN indicator flashes rapidly and the current mode is canceled. If this occurs, press the **CLEAR** button again.
- **MACRO** switch is switched to another position.
  - Another key is pressed.
  - There is no operation for about 30 seconds.

- 3 Press and hold the **CLEAR** button again. While holding the **CLEAR** button pressed, press and hold the **MASTER VOLUME** ^ and v keys simultaneously until the indicator flashes 7 times.

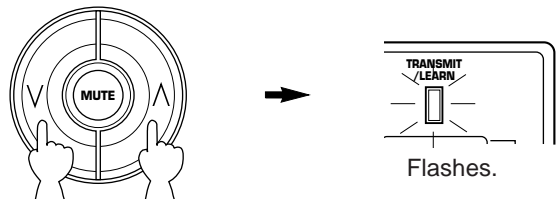

# TROUBLESHOOTING

If the unit fails to operate normally, check the following points to determine whether the fault can be corrected by the simple measures suggested. If it cannot be corrected, or if the fault is not listed in the SYMPTOM column, disconnect the power cord and contact your authorized YAMAHA dealer or service center for help.

	SYMPTOM	CAUSE	REMEDY
Amplifier	The unit fails to turn on when the POWER switch is pressed, or turns off suddenly soon after the power is turned on.	Power cord is not plugged in or is not completely inserted.	Firmly plug in the power cord.
		The IMPEDANCE SELECTOR switch on the rear panel is not set to the upper or the lower end exactly.	Set the switch to the upper or the lower end exactly.
	No sound or no picture.	Incorrect output cord connections.	Connect the cords properly. If the problem persists, the cords may be defective.
		Appropriate input source is not selected.	Select an appropriate input source with the input selector buttons.
		The SPEAKERS switches are not set properly.	Set the SPEAKERS switch which corresponds to the speakers to be used to the ON position.
		Speaker connections are not secure.	Secure the connections.
	The sound suddenly goes off.	The protection circuit has been activated because of short circuit etc.	Turning the unit off and then on will reset the protection circuit.
		The SLEEP timer has functioned.	Cancel the SLEEP timer function.
	Only one side speaker outputs the sound.	Incorrect setting of the BALANCE control.	Adjust it to the appropriate position.
		Incorrect cord connections.	Connect the cords properly. If the problem persists, the cords may be defective.
Sound "hums".	Incorrect cord connections.	Firmly connect the audio plugs. If the problem persists, the cords may be defective.	
	No connection from the turntable to the GND terminal.	Make the GND connection between the turntable and this unit.	
The volume level is low while playing a record.	The record is being played on a turntable with an MC cartridge.	The player should be connected to the unit through the MC head amplifier.	
The volume level cannot be increased, or sound is distorted.	The power to the component connected to the REC OUT terminals of this unit is off.	Turn the power to the component on.	
No sound from the rear speakers.	The sound output level to the rear speakers is set to minimum.	Raise the sound output level to the rear speakers.	
	The monaural sound source is played in DOLBY PRO LOGIC or DOLBY PRO LOGIC ENHANCED mode.	Select another program suitable for the monaural sound source.	
No sound from the center speaker.	The sound output level to the center speaker is set to minimum.	Raise the sound output level to the center speaker.	
	The center channel mode is in PHANTOM mode.	Select NORMAL or WIDE.	
	Incorrect sound field program selection.	Select the appropriate program.	
FM	FM stereo reception is noisy.	Because of the characteristics of FM stereo broadcasts, this is limited to cases where the transmitter is too far away or the antenna input is poor.	Check the antenna connections. Try using a high quality directional FM antenna. Set the TUNING MODE button to the manual tuning mode.
	There is distortion and clear reception cannot be obtained even with a good FM antenna.	There is multipath interference.	Adjust antenna placement to eliminate multipath interference.
	A desired station cannot be tuned in with the automatic tuning method.	The station is too weak.	Use the manual tuning method. Use a high quality directional FM antenna.
	Previously preset stations can no longer be tuned in.	This unit has been unplugged for a long period.	Repeat the presetting procedure.
AM	A desired station cannot be tuned in with the automatic tuning method.	Weak signal or loose antenna connections.	Tighten the AM loop antenna connections and rotate it for best reception. Use the manual tuning method.
	There are continuous crackling and hissing noises.	Noises will result from lightning, fluorescent lamps, motors, thermostats and other electrical equipment.	Use an outdoor antenna and a ground wire. This will help somewhat but it is difficult to eliminate all noise.
	There are buzzing and whining noises (especially in the evening).	A television set is being used nearby.	Relocate this unit away from the TV.
Remote control Transmitter	The remote control transmitter does not work.	Direct sunlight or lighting (of an inverter type of fluorescent lamp etc.) is striking the remote control sensor of the main unit.	Change the position of the main unit.
		The batteries of this remote control transmitter are too weak.	Replace the batteries with new ones.
Others	The sound is degraded when listening with the headphones connected to the compact disc player or cassette deck that are connected with this unit.	The power to this unit is off.	Turn the power to this unit on.

# SPECIFICATIONS

## AUDIO SECTION

Minimum RMS Output Power per Channel  
Main L, R  
8 ohms, 20 Hz to 20 kHz, 0.04% THD  
<RX-V692RDS> .....75W+75W  
<RX-V592RDS> .....70W+70W

Center  
8 ohms, 20 Hz to 20 kHz, 0.07% THD  
<RX-V692RDS> .....75W  
<RX-V592RDS> .....70W

Rear  
8 ohms, 1 kHz, 0.3% THD  
<RX-V692RDS> .....40W+40W  
<RX-V592RDS> .....35W+35W

Dynamic Power per Channel  
(by IHF Dynamic Headroom measuring method)  
<RX-V692RDS>  
8/6/4/2 ohms.....100/125/150/175W  
<RX-V592RDS>  
8/6/4/2 ohms.....95/120/150/170W

DIN Standard Output Power per Channel  
4 ohms, 1 kHz, 0.7% THD  
[Europe model only]  
<RX-V692RDS> .....120W  
<RX-V592RDS> .....110W

IEC Power  
8 ohms, 1 kHz, 0.1% THD  
[Europe model only]  
<RX-V692RDS> .....90W  
<RX-V592RDS> .....85W

Power Band Width  
<RX-V692RDS>  
8 ohms, 40W, 0.09% THD  
.....10 Hz to 50 kHz  
<RX-V592RDS>  
8 ohms, 30W, 0.09% THD  
.....10 Hz to 50 kHz

Damping Factor (SPEAKERS A)  
8 ohms, 20 Hz to 20 kHz .....80 or more

Input Sensitivity/Impedance  
PHONO MM .....2.5 mV/47 k-ohms  
CD/TAPE/DVD-LD/TV-DBS/VCR  
.....150 mV/47 k-ohms  
6CH DISCRETE INPUT DVD/LD TV/DBS  
<RX-V692RDS> .....150 mV/40 k-ohms  
<RX-V592RDS> .....150 mV/50 k-ohms

Maximum Input Signal  
PHONO MM  
1 kHz, 0.04% THD.....110 mV  
CD/TAPE/DVD-LD/TV-DBS/VCR  
(EFFECT ON)  
1 kHz, 0.5% THD.....2.2V

Output Level/Impedance  
REC OUT .....150 mV/2.5 k-ohms  
PRE OUT (MAIN).....2.2V/1.2 k-ohms  
PRE OUT (REAR).....1.6V/1.2 k-ohms  
SUBWOOFER (EFFECT OFF)  
.....6.0V/1.5 k-ohms

Headphone Jack Rated Output/Impedance  
Output Level (8 ohms, 0.04% THD).....0.5V  
Impedance.....390 ohms

Frequency Response (20 Hz to 20 kHz)  
CD/TAPE/DVD-LD/TV-DBS/VCR.....0±0.5 dB

RIAA Equalization Deviation  
PHONO MM.....0±0.5 dB

Total Harmonic Distortion (20 Hz to 20 kHz)  
PHONO MM to REC OUT  
1V .....0.02%  
CD/TAPE/DVD-LD/TV-DBS/VCR to SP OUT  
<RX-V692RDS>  
40W/8 ohms.....0.025%  
<RX-V592RDS>  
30W/8 ohms.....0.025%

Signal-to-Noise Ratio (IHF-A Network)  
PHONO MM to REC OUT  
(5 mV Input Shorted)  
<RX-V692RDS> .....83 dB  
<RX-V592RDS> .....82 dB  
CD/TAPE/DVD-LD/TV-DBS/VCR to SP OUT  
(Shorted).....98 dB

Residual Noise (IHF-A Network)  
MAIN L/R .....140 µV

Channel Separation (Vol. -30 dB, EFFECT OFF)  
PHONO MM  
(Input Shorted, 1 kHz/10 kHz)  
.....60 dB/50 dB  
CD/TAPE/DVD-LD/TV-DBS/VCR  
(Input 5.1 k-ohms Terminated,  
1 kHz/10 kHz) .....60 dB/45 dB

Tone Control Characteristics  
BASS: Boost/cut.....±10 dB (50 Hz)  
Turnover Frequency .....(350 Hz)  
TREBLE: Boost/cut.....±10 dB (20 kHz)  
Turnover Frequency.....(3.5 kHz)

Bass Extension.....+6 dB (50 Hz)

Gain Tracking Error (0 to -60 dB) .....3 dB

## VIDEO SECTION

Video Signal Type.....PAL

Video Signal Level.....1 Vp-p/75 ohms

S-Video Signal Level  
Y .....1 Vp-p/75 ohms  
C .....0.286 Vp-p/75 ohms

Maximum Input Level.....1.5 Vp-p or more  
<RX-V692RDS only>  
S-Video C .....0.5 Vp-p or more

Signal-to-Noise Ratio .....50 dB or more

Monitor Out Frequency Response  
.....5 Hz to 10 MHz, -3 dB

## FM SECTION

Tuning Range .....87.5 to 108.0 MHz

Usable Sensitivity (75 ohms)  
DIN, Mono (S/N 26 dB) .....0.9 µV  
DIN, Stereo (S/N 46 dB).....24 µV

Image Response Ratio .....80 dB

IF Response Ratio .....80 dB

Spurious Response Ratio .....70 dB

AM Suppression Ratio .....55 dB

Capture Ratio.....1.5 dB

Selectivity (two signals, 40 kHz Dev. ±300 kHz)  
.....70 dB

Signal-to-Noise Ratio  
(DIN-Weighted, 40 kHz Dev.)  
Mono/Stereo.....75 dB/70 dB

Harmonic Distortion  
Mono/Stereo (40 kHz Dev.) .....0.1/0.2%

Stereo Separation (40 kHz Dev.).....50 dB

Frequency Response  
20 Hz to 15 kHz .....0 ±1.5 dB

## AM SECTION

Tuning Range.....531 to 1,611 kHz

Usable Sensitivity .....100 µV/m

Selectivity .....32 dB

Signal-to-Noise Ratio .....50 dB

Image Response Ratio.....40 dB

Spurious Response Ratio.....50 dB

Harmonic Distortion (1 kHz) .....0.3%

## AUDIO SECTION

Output Level/Impedance (40 kHz Dev.)  
FM (100% mod., 1 kHz)...400 mV/2.2 k-ohms  
AM (30% mod., 1 kHz) ....150 mV/2.2 k-ohms

## GENERAL

Power Supply .....AC 230V, 50 Hz

Power Consumption  
<RX-V692RDS> .....290W  
<RX-V592RDS> .....270W

AC Outlets  
2 SWITCHED OUTLETS  
[Europe model] .....100W max. total  
1 SWITCHED OUTLET  
[U.K. model].....100W max. total

Dimensions (W x H x D)  
.....435 x 151 x 379.5 mm  
(17-1/8" x 5-15/16" x 14-15/16")

Weight  
<RX-V692RDS> .....12.5 kg (27 lbs. 8 oz.)  
<RX-V592RDS> .....11.0 kg (24 lbs. 3 oz.)

Accessories .....AM loop antenna  
Indoor FM antenna  
75-ohm/300-ohm antenna adapter  
(U.K. model only)  
Remote control transmitter  
Batteries  
<RX-V692RDS only>  
User function stickers

Specifications are subject to change without notice.

# SPECIFICATIES

## AUDIO GEDEELTE

Minimum RMS uitgangsvermogen per Kanaal  
Hoofd

8 ohm, 20 Hz tot 20 kHz, 0,04% Totale  
Harmonische Vervorming  
<RX-V692RDS> .....75W+75W  
<RX-V592RDS> .....70W+70W

Midden

8 ohm, 20 Hz tot 20 kHz, 0,07% Totale  
<RX-V692RDS> .....75W  
<RX-V592RDS> .....70W

Achterste

8 ohm, 1 kHz, 0,3% Totale Harmonische  
Vervorming  
<RX-V692RDS> .....40W+40W  
<RX-V592RDS> .....35W+35W

Dynamische Vermogen per Kanaal (IHF  
Meetmethode voor Vrij Dynamisch Bereik)

8/6/4/2 ohm  
<RX-V692RDS> .....100/125/150/175W  
<RX-V592RDS> .....95/120/150/170W

DIN Standaard Uitgangsvermogen per Kanaal  
4 ohm, 1 kHz, 0,7% Totale Harmonische  
Vervorming

[Alleen modellen voor Europa]  
<RX-V692RDS> .....120W  
<RX-V592RDS> .....110W

IEC Vermogen

8 ohm, 1 kHz, 0,1% Totale Harmonische  
Vervorming  
[Alleen modellen voor Europa]  
<RX-V692RDS> .....90W  
<RX-V592RDS> .....85W

Vermogensbandbreedte

<RX-V692RDS>  
8 ohm, 40W, 0,09% Totale Harmonische  
Vervorming .....10 Hz tot 50 kHz  
<RX-V592RDS>  
8 ohm, 30W, 0,09% Totale Harmonische  
Vervorming .....10 Hz tot 50 kHz

Dempingsfactor (SPEAKERS A)

8 ohm, 20 Hz tot 20 kHz .....80 of meer

Ingangsgevoeligheid/Impedantie

PHONO MM .....2,5 mV/47 k-ohm  
CD/TAPE/DVD-LD/TV-DBS/VCR  
.....150 mV/47 k-ohm  
6CH DISCRETE INPUT DVD/LD TV/DBS  
<RX-V692RDS> .....150 mV/40 k-ohm  
<RX-V592RDS> .....150 mV/50 k-ohm

Maximum Ingangssignaalniveau

PHONO MM  
1 kHz, 0,04% Totale Harmonische  
Vervorming .....110 mV  
CD/TAPE/DVD-LD/TV-DBS/VCR (EFFECT  
ON)  
1 kHz, 0,5% Totale Harmonische  
Vervorming .....2,2V

Uitgangsniveau/Impedantie

REC OUT .....150 mV/2,5 k-ohm  
PRE OUT (MAIN) .....2,2V/1,2 k-ohm  
PRE OUT (REAR) .....1,6V/1,2 k-ohm  
SUBWOOFER (EFFECT OFF)  
.....6,0V/1,5 k-ohm

Nominaal Uitgangsvermogen/Impedantie van  
Hoofdtelefoon-ingang

Uitgangsniveau (8 ohm, 0,04% Totale  
Harmonische Vervorming) .....0,5V

Impedantie .....390 ohm

Frekventiebereik (20 Hz tot 20 kHz)

CD/TAPE/DVD-LD/TV-DBS/VCR  
.....0±0,5 dB

RIAA Balans Afwijking

PHONO MM .....0±0,5 dB

Totale Harmonische Vervorming (20 Hz tot 20  
kHz)

PHONO MM naar REC OUT  
40W/8 ohm .....0,02%  
1V .....0,02%  
CD/TAPE/DVD-LD/TV-DBS/VCR naar SP  
OUT  
<RX-V692RDS>  
40W/8 ohm .....0,025%  
<RX-V592RDS>  
30W/8 ohm .....0,025%

Signaal/Ruis Verhouding (IHF-A Network)

PHONO MM naar REC OUT (5 mV  
Ingangssignaal Kortgesloten)  
<RX-V692RDS> .....83 dB  
<RX-V592RDS> .....82 dB  
CD/TAPE/DVD-LD/TV-DBS/VCR naar SP  
OUT (Kortgesloten) .....98 dB

Reststoring (IHF-A Network)

MAIN L/R .....140 µV

Kanaalscheiding (Vol. -30 dB, EFFECT OFF)

PHONO MM  
(Ingangssignaal Kortgesloten,  
1 kHz/10 kHz) .....60 dB/50 dB  
CD/TAPE/DVD-LD/TV-DBS/VCR  
(Ingangsvermogen 5,1 k-ohm Kortgesloten,  
1 kHz/10 kHz) .....60 dB/45 dB

Karakteristieken van Klankregeling

BASS: Versterking/afsluiting  
.....±10 dB (50 Hz)  
Omzetfrequentie .....(350 Hz)  
TREBLE: Versterking/afsluiting  
.....±10 dB (20 kHz)  
Omzetfrequentie .....(3,5 kHz)

Bass Extension .....+6 dB (50 Hz)

Spoorafwijking van Versterking (0 tot -60 dB)

.....3 dB

## VIDEO GEDEELTE

Video-signaaltype .....PAL

Video-signaalniveau .....1 Vp-p/75 ohm

S-video-signaalniveau

Y .....1 Vp-p/75 ohm  
C .....0,286 Vp-p/75 ohm

Maximum ingangsniveau .....1,5 Vp-p of meer

<Alleen RX-V692RDS>  
S-Video C .....0,5 Vp-p of meer

Signaal/ruis verhouding .....50 dB of meer

Monitor-uit frekwentierespons

.....5 Hz tot 10 MHz, -3 dB

## FM GEDEELTE

Afstembereik .....87,5 tot 108,0 MHz

Effectieve Gevoeligheid (75 ohm)

DIN, Mono (Signaal/Ruis 26 dB) .....0,9 µV  
DIN, Stereo (Signaal/Ruis 46 dB) .....24 µV

Spiegelfrequentie Verhouding .....80 dB

IF Frekwentiebereik Verhouding .....80 dB

Parasitaire Frekwentieverhouding .....70 dB

AM Ruisonderdrukkingsverhouding .....55 dB

Opvangfrekwentieverhouding .....1,5 dB

Selectiviteit (twee signalen, 40 kHz Afw. ±300  
kHz) .....70 dB

Signaal/Ruisverhouding  
(DIN-norm, 40 kHz Dev.)

Mono/Stereo .....75/70 dB

Harmonische Vervorming

Mono/Stereo (40 kHz Afw.) .....0,1/0,2%

Stereo Scheiding (40 kHz Afw.) .....50 dB

Frekventiebereik

20 Hz tot 15 kHz .....0 ± 1,5 dB

## AM GEDEELTE

Afstembereik .....531 tot 1.611 kHz

Effectieve Gevoeligheid .....100 µV/m

Selectiviteit .....32 dB

Signaal/Ruisverhouding .....50 dB

Spiegelfrequentie Verhouding .....40 dB

Parasitaire Frekwentieverhouding .....50 dB

Harmonische Vervorming (1 kHz) .....0,3%

## AUDIO GEDEELTE

Uitgangsniveau/Impedantie (40 kHz Afw.)  
FM (100% mod. 1 kHz) .....400 mV/2,2 k-ohm  
AM (30% mod. 1 kHz) .....150 mV/2,2 k-ohm

## ALGEMEEN

Spanningsvereisten  
.....230V, 50 Hz wisselstroom

Stroomverbruik

<RX-V692RDS> .....290W  
<RX-V592RDS> .....270W

Netspanningsuitgangen (AC OUTLETS)

2 GESCHAKELDE  
NETSPANNINGSUITGANGEN  
[Modellen voor Europa]  
.....Max. totaal vermogen: 100W

1 GESCHAKELDE  
NETSPANNINGSUITGANG  
[Modellen voor Groot-Brittannië]  
.....Max. totaal vermogen: 100W

Afmetingen (L x H x B)

.....435 x 151 x 379,5 mm

Gewicht

<RX-V692RDS> .....12,5 kg  
<RX-V592RDS> .....11,0 kg

Toebehoren .....AM Lusantenne

FM Binnenantenne  
75 ohm/300 ohm antenne-adaptor (Alleen  
modellen voor Groot-Brittannië)  
Afstandbediening  
Batterijen

<Alleen RX-V692RDS>  
Gebruikersfunctie-stickers

Alle specificaties zijn onder voorbehoud en  
kunnen zondere nadere kennisgeving worden  
gewijzigd.